

FERTIKIT™ 3G

USER MANUAL

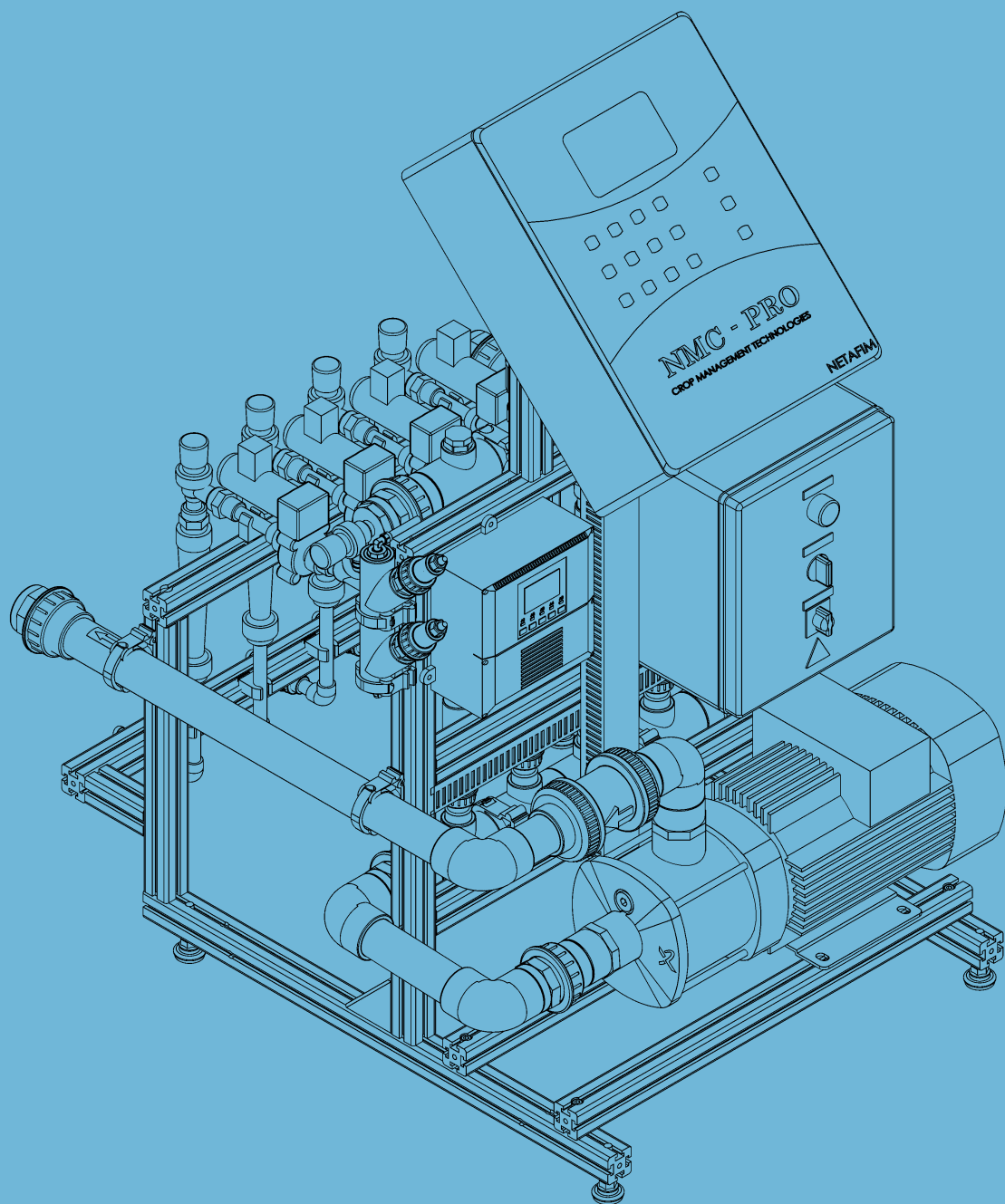

© COPYRIGHT 2020, NETAFIM™

NO PARTS OF THIS PUBLICATION MAY BE REPRODUCED, STORED IN AN AUTOMATED DATA FILE OR MADE PUBLIC IN ANY FORM OR BY ANY MEANS, WHETHER ELECTRONIC, MECHANICAL, BY PHOTOCOPYING, RECORDING OR IN ANY OTHER MANNER WITHOUT PRIOR WRITTEN PERMISSION OF THE PUBLISHER.

ALTHOUGH NETAFIM™ TAKES THE GREATEST POSSIBLE CARE IN DESIGNING AND PRODUCING BOTH ITS PRODUCTS AND THE ASSOCIATED DOCUMENTATION, THEY MAY STILL INCLUDE FAULTS.

NETAFIM™ WILL NOT ACCEPT RESPONSIBILITY FOR DAMAGE RESULTING FROM USE OF NETAFIM'S PRODUCTS OR USE OF THIS MANUAL.

NETAFIM™ RESERVES THE RIGHT TO MAKE CHANGES AND IMPROVEMENTS TO ITS PRODUCTS AND/OR THE ASSOCIATED DOCUMENTATION WITHOUT PRIOR NOTICE.



FOREIGN LANGUAGES

In the event that you are reading this manual in a language other than the English language, you acknowledge and agree that the English language version shall prevail in case of inconsistency or contradiction in interpretation or translation.

CONTENTS

Symbols	4
Safety	
Safety instructions	5
When using acid/chemicals	6
Description	
Introduction	7
Advantages	7
Basic functions	7
Operating principle	8
Modularity	8
Compatibility	8
Service	8
Maintenance	8
Typical installation overview	9
Main parts of the FertiKit™ 3G and its infrastructure	9
The 8 modes	9
PL modes (PL/PS/PR/RL)	10
PB mode	11
SP mode	12
MS mode (MS/RS)	13
IL mode	14
ST mode	15
PD mode	16
MX mode	17
Operation and maintenance	
Operation	18
Maintenance	19
Winterization	20
Troubleshooting	
Symptoms regarding more than one single dosing channel	21
Symptoms regarding a single dosing channel	22
Symptoms while idle	23
Switchboard warning	24
Calibration	
1. Calculation of dosing channels opening percentage	25
2. Simulation with a 10 liter (2 US gal) bucket of water	25
3. Calibration of the FertiKit™ while irrigating	27
List of parts	
Spare parts of the FertiKit™ 3G 8 modes	29
Dosing channels	40
Venturis	44
Fertikit 3G hydraulic condition checklist	45
Warranty	46

SYMBOLS

The symbols used in this manual refer to the following:



WARNING

Contains instructions aimed at preventing bodily injury or direct damage to the crops, the FertiKit™ 3G and/or the infrastructure.



CAUTION

Contains instructions aimed at preventing unwanted system operation, installation or conditions that, if not followed, might void the warranty.



ATTENTION

Contains instructions aimed at enhancing the efficiency of usage of the instructions in the manual.



NOTE

Contains instructions aimed at emphasizing certain aspect of the operation of the system or installation.



ACID HAZARD

Contains instructions aimed at preventing bodily injury or direct damage to the crops, the product and/or the infrastructure in the presence of acid.



ELECTRICAL HAZARD

Contains instructions aimed at preventing bodily injury or direct damage to the FertiKit™ 3G and/or the infrastructure in the presence of electricity.



SAFETY FOOTWEAR

Contains instructions aimed at preventing foot injury.



PROTECTIVE EQUIPMENT

Contains instructions aimed at preventing damage to health or bodily injury in the presence of fertilizers, acid or other chemicals.



EXAMPLE

Provides an example to clarify the operation of the settings, method of operation or installation. The values used in the examples are hypothetical. Do not apply these values to your own situation.



TIP

Provides clarification, tips or useful information.

SAFETY



CAUTION

Read the Safety instructions chapter before using, maintaining or troubleshooting the FertiKit™ 3G.

Safety instructions

- All safety regulations must be applied.
- Ensure that the installation is carried out in a manner that prevents leaks from the FertiKit™, the fertilizer/acid tanks and lines, the peripherals and the accessories (contaminating the environment, soil or ambient area).
- When using acid always observe the acid manufacturer's safety instructions.
- Electrical installation and troubleshooting should be performed by an authorized electrician only.
- The electrical installation must comply with the local safety standards and regulations.
- Installation should be performed by authorized technicians only.
- Protection provided by the equipment can be impaired if the equipment is used in a manner other than that specified by the manufacturer.



WARNING

In agricultural environment - always wear protective footwear.



WARNING

Always use protective equipment, gloves and goggles when handling fertilizers, acid and other chemicals!



WARNING

Measures must be taken to prevent fertilizer infiltration of the water source, to avoid water pollution.



CAUTION

When opening or closing any manual valve, always do it gradually, to prevent damage to the system by water hammer.



NOTE

The maximum sound level produced by the equipment does not exceed 70dB.

SAFETY

When using acid/chemicals



ACID HAZARD

When using acid - always observe the acid manufacturer's safety instructions.



WARNING

Always use protective equipment, gloves and goggles when handling fertilizers, acid and other chemicals!



CAUTION

There are fertilizer combinations that at high concentration might induce crystallization in the FertiKit's lower manifold and cause clogging of the pipes.

Fertilizer combinations prone to induce crystallization:

- Calcium Nitrate + Ammonium Sulfate => Calcium Sulfate
- Calcium Nitrate + Potassium Sulfate => Calcium Sulfate
- MKP + Calcium Nitrate => Calcium Phosphate
- MAP + Calcium Nitrate => Calcium Phosphate
- Phosphoric acid + Calcium Nitrate => Calcium Phosphate

When injecting these fertilizer combinations:

- Make sure to dilute each fertilizers to the allowed concentration in the fertilizer tank prior to injection through the FertiKit™.
- Immediately after each injection of any of the fertilizer combination above, flush the FertiKit™ with clean water for at least 2 minutes.

In case of doubt regarding the use of any combination of fertilizers, contact your Netafim™ local representative.



ATTENTION

When dosing acid, use a dosing channel fitted with the appropriate components according to the type and concentration of acid used*:

Type of dosing channel	Diaphragm and O-rings	For pH correction					For maintenance of drippers		
		Nitric acid (HNO ₃)	Phosphoric acid (H ₃ PO ₄)	Sulfuric acid (H ₂ SO ₄)	Potassium hydroxide (KOH)	Acetic acid (CH ₃ COOH)	Hydrochloric (HCl)	Hydrogen peroxide (H ₂ O ₂)	Chlorine (as hypochloride)
For diluted acid	EPDM	<3%	<85%	<30%	<35%	<30%	<10%	<30%	<1%
For concentrated acid	Viton	<40%	<85%	<90%	<10%	<5%	<33%	<50%	<10%

% is by weight at 21°C (70°F)

*The table indicates the resistance of the dosing channel components to acid, and is not a recommendation to use the acids mentioned.



WARNING

Exceeding the recommended acid concentrations will damage the dosing channels.



WARNING

Substances such as chemicals for pest/disease control might be corrosive and damage the FertiKit™ 3G. When using any substance other than fertilizers or acids not exceeding the concentrations in the table above, always observe the manufacturer's instructions for corrosivity. In case of any doubt, contact your Netafim™ local representative.

DESCRIPTION

Introduction

The FertiKit™ 3G is a fully configurable fertilizer/acid dosing unit - a highly cost-effective solution for precise Nutrigation™.

Based on a standard platform, the FertiKit™ offers 8 different operation modes, selectable according to the site conditions, in order to maximize usage of available water flow rate and pressure on the main irrigation line, ensuring the highest efficiency with minimum investment.

The FertiKit™ can accommodate a variety of dosing channels, dosing boosters, controllers, peripherals and accessories to meet a vast range of applications and infrastructure constraints.

Capacity range

The FertiKit™ ensures a satisfactory mixture in an extremely vast range of flow capacities.

It will accommodate a 0.1 Ha (0.25 Acres) nursery or a 400 Ha (1000 Acres) sugar cane plantation.

Main line pressure range: up to 8.5 bars (123.0 PSI).

Main line flow rate range: from 1.0 to 700.0 m³/h (from 4.4 to 3000.0 GPM).

Advantages

- A modular Nutrigation™ system for soil or substrate applications with minimum investment
- Efficient usage of water, fertilizers and energy
- Unrivaled range of irrigation water capacities
- Designed for any application where quantitative or proportional Nutrigation™ is required
- Highly profitable price/performance ratio
- Venturi operating principle - no moving parts
- Fits easily into any existing irrigation system
- Precise Nutrigation™ based on high-accuracy dosing channels
- Quick action dosing valves
- Available with up to 6 fertilizer/acid dosing channels
- Nutrigation™ recipes can be changed quickly and efficiently
- Can be operated manually or fully computerized
- NMC and other controllers can be assembled on the FertiKit™ for advanced Nutrigation™ control
- A wide variety of accessories and peripherals can be integrated into the FertiKit™ to enhance its functions
- High-quality components and PVC pipe work
- Aluminum, corrosion-resistant frame with adjustable legs
- Easy to install and to maintain
- Made by Netafim™

Basic functions

The FertiKit™ supports the following Nutrigation™ functions:

- Fully controlled dosing and mixing of fertilizers/acid with source water into a homogenous nutrient solution.
- EC/pH correction of the nutrient solution.
- Water pre-treatment

DESCRIPTION

Operating principle

The FertiKit™ doses the various fertilizers and acid into a homogeneous solution and injects it into the irrigation water main line. The suction of the fertilizers and acid in the dosing channels is based on the Venturi principle. This requires a pressure differential - available on the main line or supplied by the main line pump or the FertiKit's dosing booster.

Modularity

The modular FertiKit™ 3G concept is based upon an array of interchangeable components that enables rapid assembly of a wide range of configurations.

Each FertiKit™ is delivered according to the precise customer's order, either fully factory assembled or assembled by the local dealer.

The dealer stocks the assortment of the FertiKit™ interchangeable components.

This concept enables the dealer to assemble any specific FertiKit™ according to the customer's order, saving the need to stock a large quantity of fully assembled FertiKit™ units of various common configurations.

The modular FertiKit™ 3G concept ensures prompt delivery schedules without delays!

Stock selection option

Enables the dosing of multiple fertilizers through a single dosing channel (in cases where simultaneous dosing is not required). Suits all modes of FertiKit™. Available in a wide variety of configurations, from a single dosing channel with 2 fertilizers to as many dosing channels and fertilizers as required. There are fertilizer combinations that at high concentration might induce crystallization in the FertiKit's lower manifold and cause clogging of the pipes (see [CAUTION](#) on page 6).

Compatibility

The FertiKit™ 3G can be incorporated in an existing or a planned project; in either case it offers a highly cost-effective solution for Nutrigation™ by taking maximum advantage of the infrastructure conditions. Any available pressure surplus can be used for the FertiKit's operation. In order to configure the most cost-effective FertiKit™, making the maximum use of available pressure.



ATTENTION

Calculations are either in metric or in US units - consistency in the type of units used is essential.

Service

Servicing the FertiKit™ 3G is a prompt and simple process. The dealer keeps a small quantity of interchangeable components on hand, for replacement on site within a few minutes.

Maintenance

To prevent failures and extend the life cycle of the FertiKit™, regular maintenance must be carried out by the user, such as periodic rinsing of filters and calibration of the EC/pH sensors. For full maintenance instructions, see [Maintenance](#) (page 19).

DESCRIPTION

Typical installation overview

The drawing below represents the typical infrastructure suitable for the **PL** mode. Each one of the FertiKit™ 3G 8 modes fits a different infrastructure configuration. (see the schematic diagrams in [Modes](#), pages 10-18).

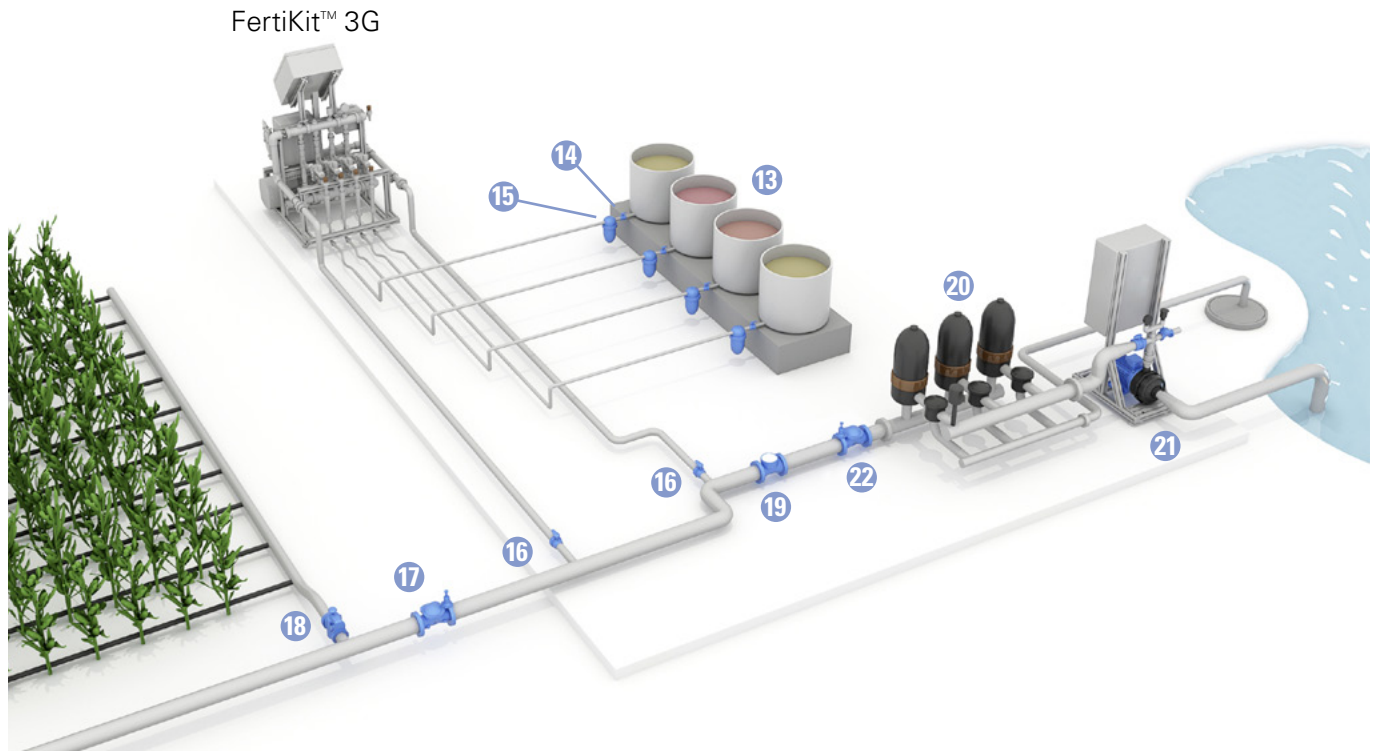

Main parts of the FertiKit™ 3G and its infrastructure

The list below presents the Main parts of the FertiKit™ and the parts of the infrastructure required for the operation of the FertiKit™ various modes (see [pages 10-18](#)).

- | | | |
|---------------------------------|--|--|
| 1 Dosing channel + Venturi | 12 Pressure switch | 22 Main line pressure reducing valve (PRV) |
| 2 Upper manifold pressure gauge | 13 Fertilizer/acid stock tank | 23 Sampling outlet |
| 3 Lower manifold pressure gauge | 14 Manual valve (fertilizer) | 24 Saddle fitting |
| 4 Sampling outlet | 15 Fertilizer/acid filter | 25 Command tube |
| 5 Controller | 16 Manual valve (isolation) | 26 Pressure sustaining valve (PSV) |
| 6 EC sensor | 17 Main line pressure sustaining valve (PSV) | 27 Pressure reducing valve (PRV) |
| 7 pH sensor | 18 Irrigation valve | 28 Water meter |
| 8 EC/pH transmitter | 19 Water meter | 29 Air release valve |
| 9 Dosing booster | 20 Main line filter | |
| 10 Dosing booster switchbox | 21 Main line pump | |
| 11 Check valve | | |

Color code: ● Supplied (part of the FertiKit™), ● Not supplied (part of infrastructure), ● Optional.

The 8 modes

Each one of the FertiKit™ 3G 8 modes depicted on the following pages fits a specific infrastructure configuration.

DESCRIPTION

PL modes (PL/PS/PR/RL)

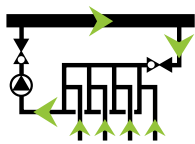

Operating principle: The pressure differential required to generate fertilizer suction via the Venturis is produced by a booster pump integrated in the FertiKit™.

These modes of operation, where the lower manifold is under low pressure (around 0 bars/PSI), permits the use of high-efficiency Venturis with high suction capacity and low motive flow consumption.

Flow rate: 20 - 700 m³/h (85 - 3000 GPM)

Suitable for main line pressure:

PL: 2.5 - 6.5 bars (36 - 94 PSI).

PR with PRV **27**: 6.5 - 8.5 bars (94 - 123 PSI)

PS with PSV **26**: Based on cavitation risk.

RL with PRV **27** and PSV **26**: 2.5 - 8.5 bars (36 - 123 PSI)

Dosing channels:

Accommodates a wide variety of dosing channels for fertilizer and concentrated/diluted acid:

- 50Hz: Up to 6 x 50 - 1000 l/h (13 - 265 GPH)
- 60Hz: Up to 5 x 50 - 1000 l/h (13 - 265 GPH)
- 60Hz: Includes compensation channel
- Optional - Concentrated acid channel, 50 l/h (13 GPH).

Total fertilizer/acid suction capacity:

- 50Hz: up to 6000 l/h (1585 GPH).
- 50Hz: up to 5000 l/h (1320 GPH).

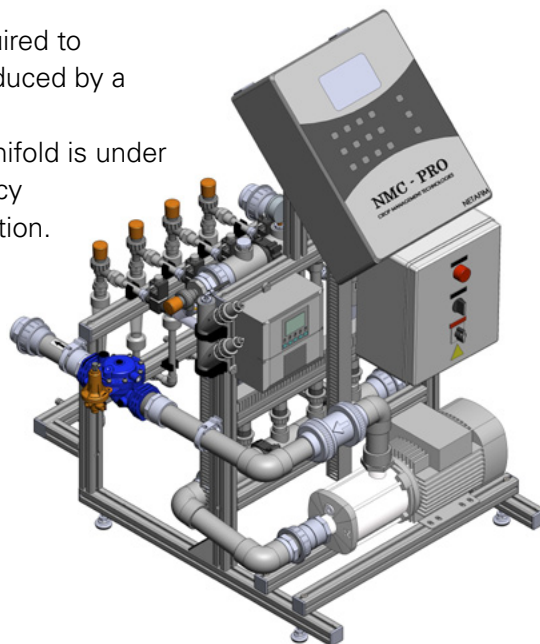

Controller: NMC-Pro, NMC-XL, NMC-Junior, (Other controllers or manual system without controller - optional).

EC/pH: Single, monitoring and control.

Schematic diagram

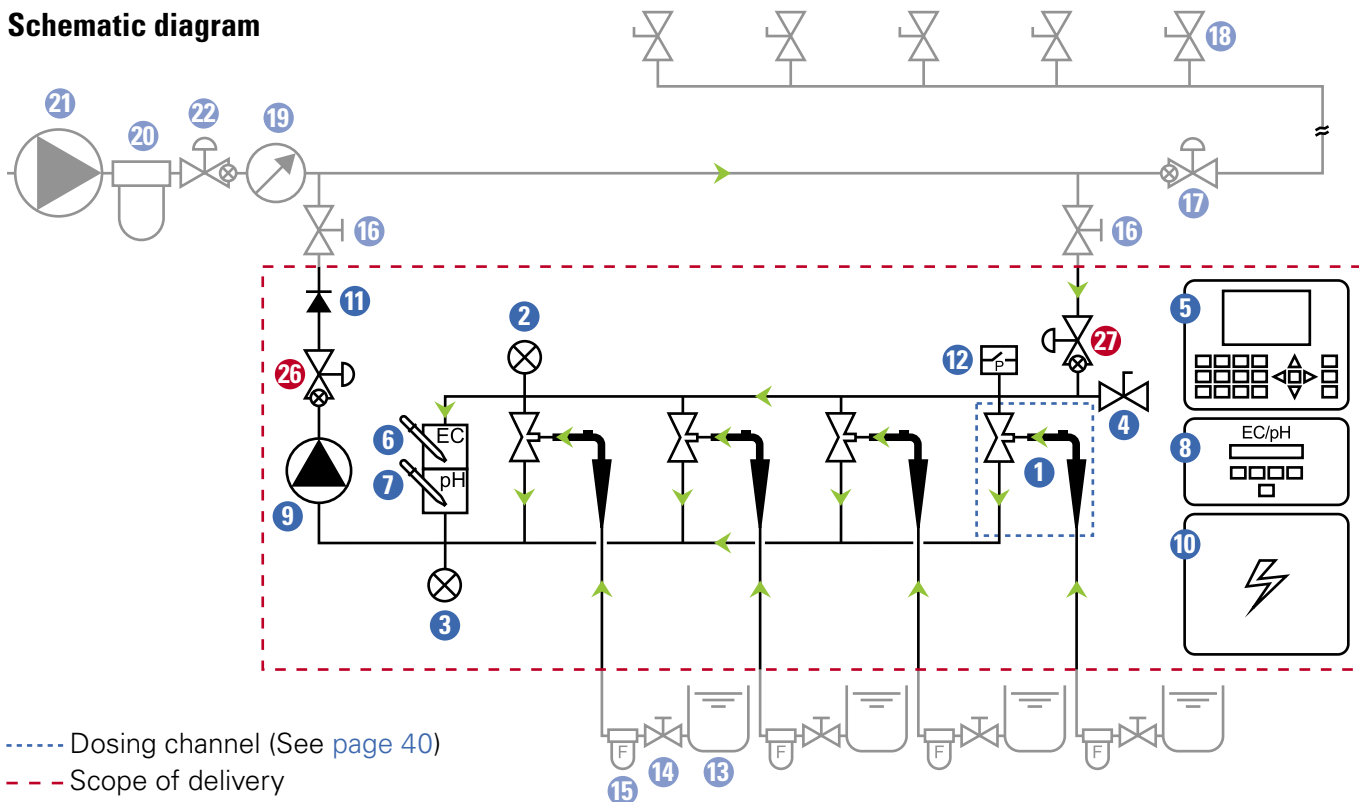

----- Dosing channel (See page 40)

- - - - - Scope of delivery

→ Direction of flow

See Legend on page 9

DESCRIPTION

PB mode

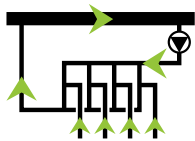

Operating principle: The pressure differential required to generate fertilizer suction via the Venturis is produced by a booster pump integrated in the FertiKit™. This mode of operation, where the smaller system pump

is installed upstream from the Venturis, permits the use of a small booster pump, reducing the investment required and saving energy. This mode is suitable for relatively low flow rates and pressures.

Flow rate: 5 - 70 m³/h (22 - 300 GPM)

Suitable for main line pressure: 1.5 - 2.5 bars (22 - 36 PSI)

Additional conditions:

The pressure supplied by the dosing booster is added to the main line pressure. Their sum (in the upper manifold) should not exceed 6.5 bars (94 PSI)

Dosing channels:

Accommodates a wide variety of dosing channels for fertilizer and concentrated/diluted acid:

- Up to 4 x 50 - 370 l/h (13 - 100 GPH)
 - Optional - Concentrated acid channel, 50 l/h (13 GPH).
- Total fertilizer/acid suction capacity - up to 1480 l/h (390 GPH).

Controller: NMC-Pro, NMC-XL, NMC-Junior, (Other controllers or manual system without controller - optional).

EC/pH: Single, monitoring and control.

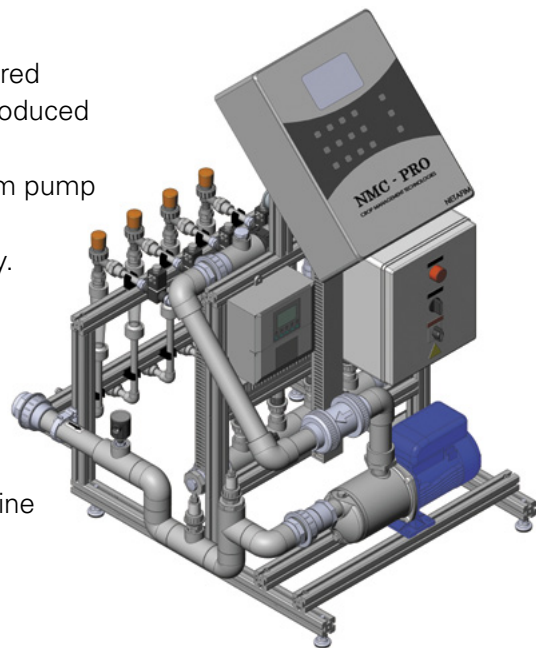

Schematic diagram

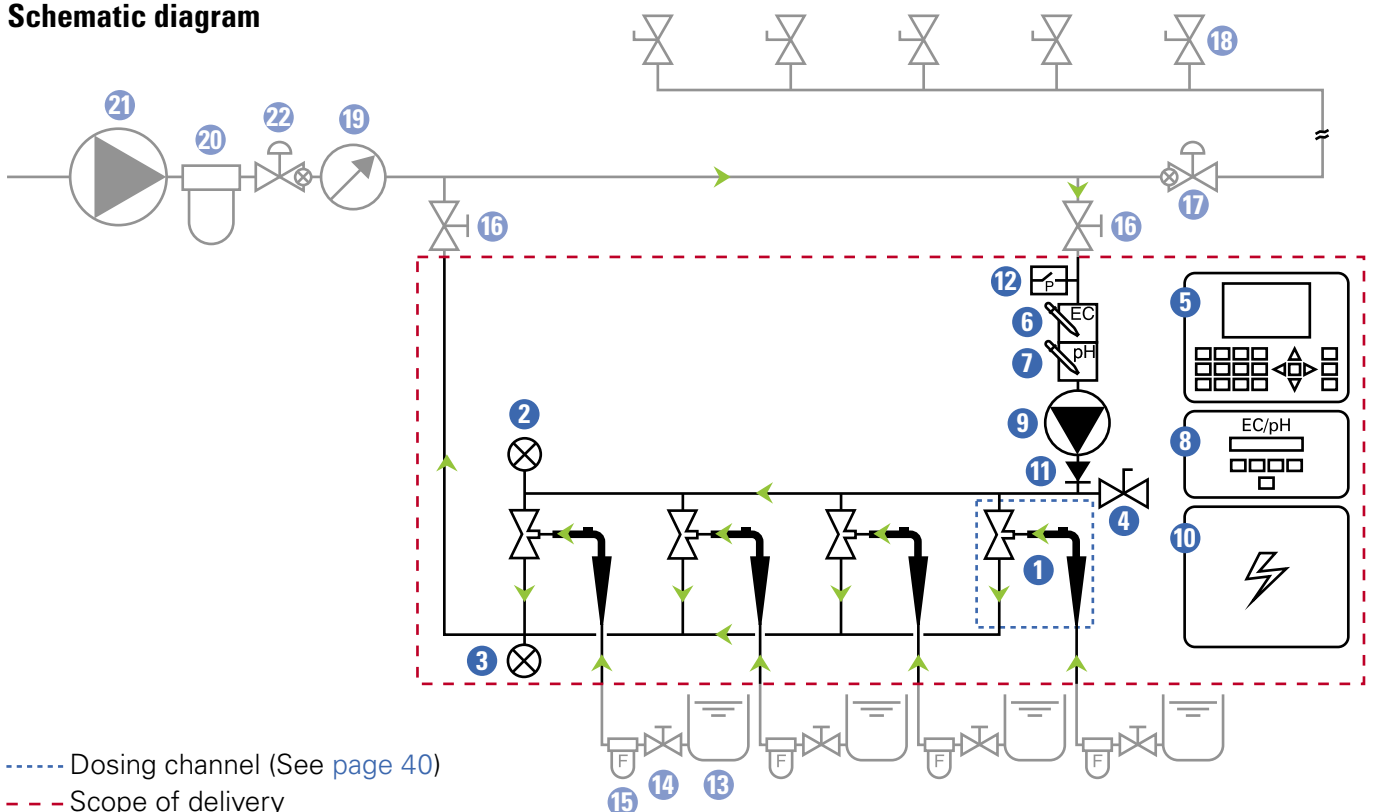

----- Dosing channel (See page 40)

- - - - - Scope of delivery

→ Direction of flow

See Legend on page 9

DESCRIPTION

SP mode

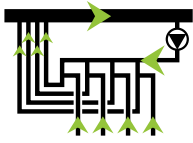

Operating principle: The pressure differential required to generate fertilizer suction via the Venturis is produced by a booster pump integrated in the FertiKit™.

This mode of operation, where the system pump is installed upstream from the Venturis, permits the use of a smaller booster pump, reducing the investment required and saving energy. This mode is suitable for relatively low flow rates and pressures. For applications that use very high concentration fertilizers and acid. The solution has to be mixed in the main line. SP mode is not equipped with a lower manifold. (Can be supplied to the USA market with all parts inch-based to facilitate replacement using locally available spare parts).

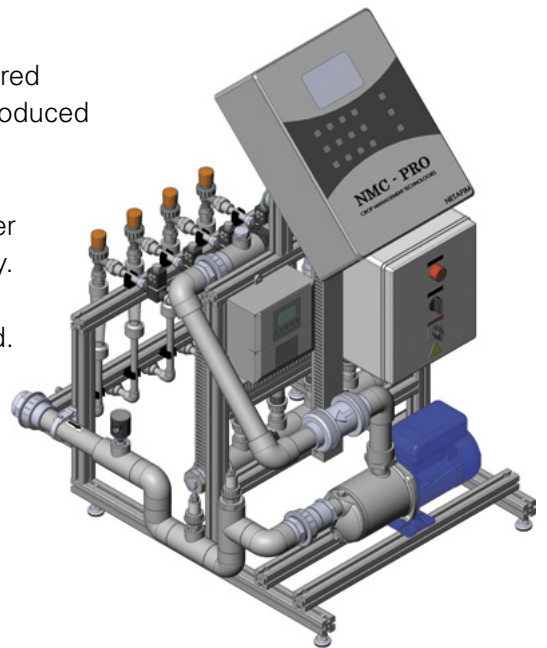

Flow rate: 5 - 250 m³/h (22 - 1100 GPM)

Suitable for main line pressure: 1.5 - 3.5 bars (22 - 51 PSI)

Dosing channels:

Accommodates a wide variety of dosing channels for fertilizer and concentrated/diluted acid:

- Up to 4 x 50 - 370 l/h (13 - 100 GPH)
- Optional - Concentrated acid channel, 50 l/h (13 GPH).

Total fertilizer/acid suction capacity - up to 1480 l/h (400 GPH).

Controller: NMC-Pro, NMC-XL, NMC-Junior, (Other controllers or manual system without controller - optional).

EC/pH: Single, monitoring and control.

Schematic diagram

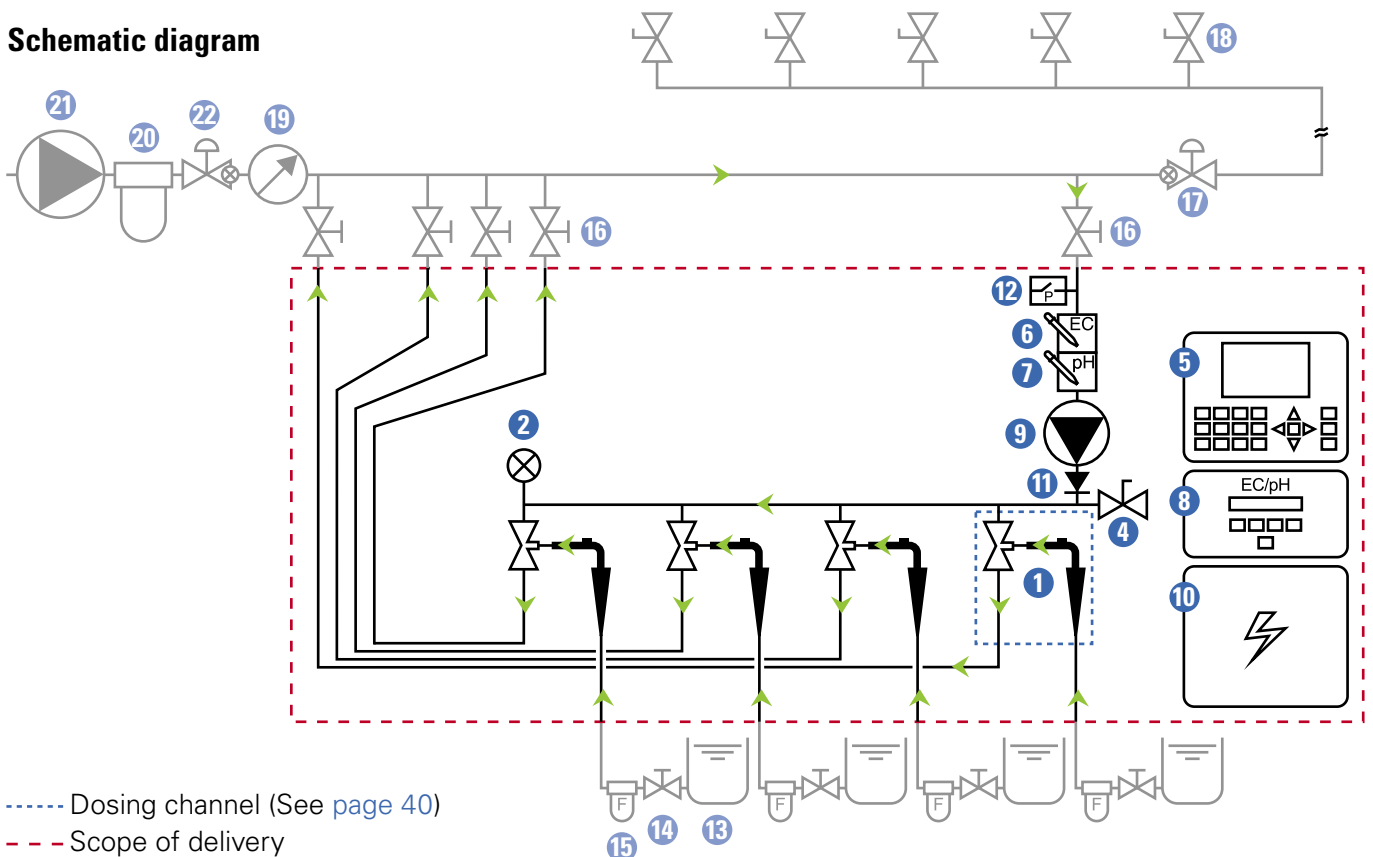

----- Dosing channel (See page 40)

- - - - - Scope of delivery

→ Direction of flow

See Legend on page 9

DESCRIPTION

MS mode (MS/RS)

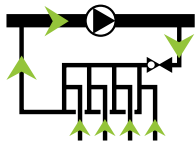

Operating principle: For systems operating under negative suction - from a reservoir or a tank [max. height: 6 meters (20 feet)]
Utilizes the main line pump pressure.
Saves the need for a dosing booster.

Flow rate: 20 - 700 m³/h (85 - 3000 GPM)

Suitable for main line pressure:

Upstream from the pump: -0.3 – +0.6 bar (-4 – +9 PSI)
At the outlet of the pump: 2.5 – 6.5 bars (36 – 94 PSI)

RS with PRV **27**:

6.5 – 8.5 bars (94 – 123 PSI) at the FertiKit™ inlet.

Additional conditions:

Requires the connection of the FertiKit's outlet to the main line upstream from the pump.

The main line pump should be able to deliver the flow rate required for the operation of the FertiKit™ + the field consumption.

Dosing channels:

Accommodates a wide variety of dosing channels for fertilizer and concentrated/diluted acid:

- Up to 6 x 50 - 1000 l/h (13 - 265 GPH)
 - Optional - Concentrated acid channel, 50 l/h (13 GPH).
- Total fertilizer/acid suction capacity - up to 6000 l/h (1585 GPH).

Controller: NMC-Pro, NMC-XL, NMC-Junior, (Other controllers or manual system without controller - optional).

EC/pH: Single, monitoring and control.

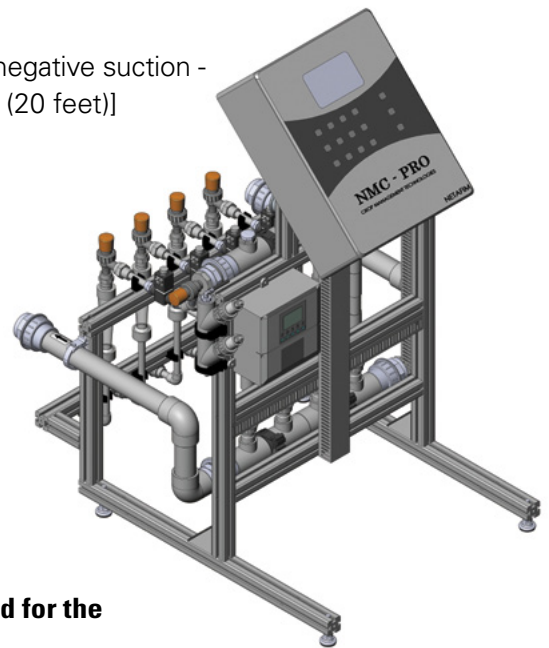

Schematic diagram

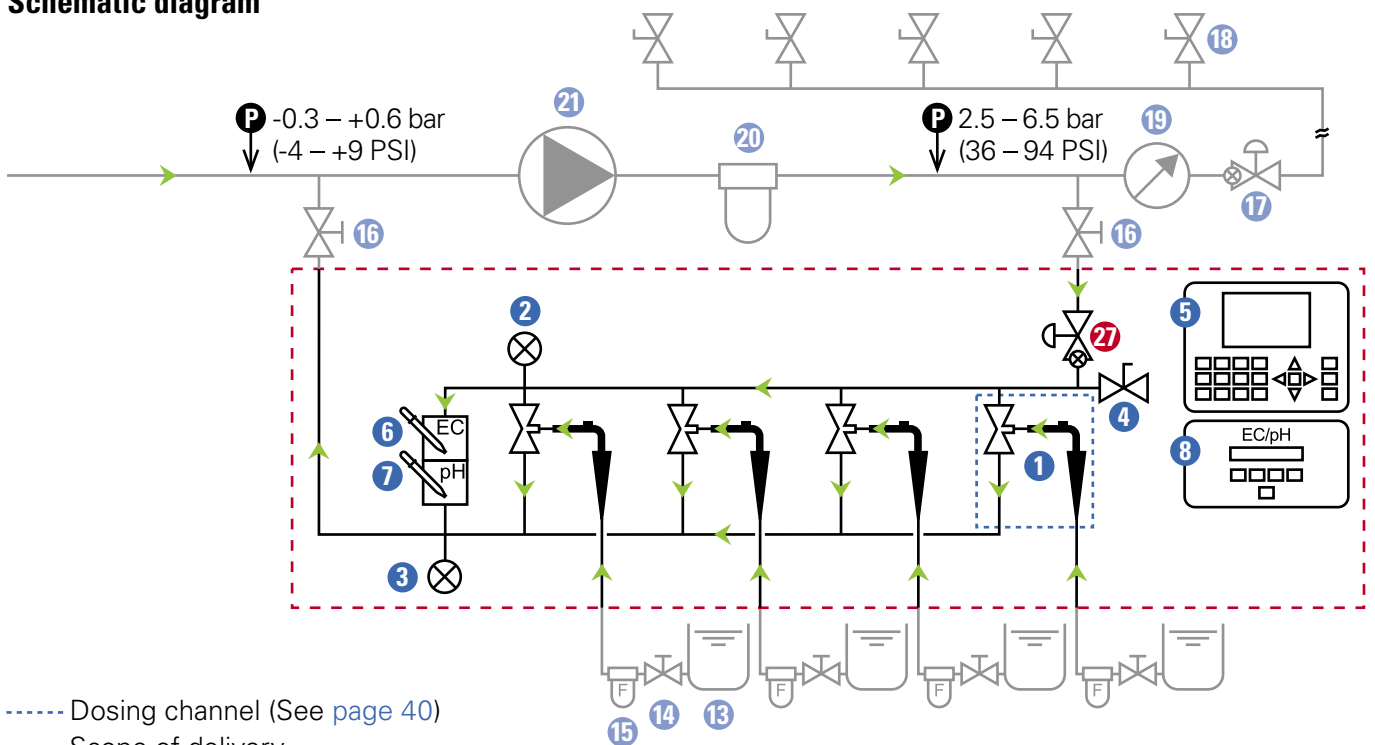

----- Dosing channel (See page 40)

- - - - - Scope of delivery

→ Direction of flow

See Legend on page 9

DESCRIPTION

IL mode

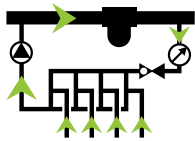

Operating principle: The pressure differential required to generate fertilizer suction via the Venturis is produced by a booster pump integrated in the FertiKit™.

In this mode of operation, the lower manifold is at low pressure (around 0 bar/psi) this allows the use of high-efficiency Venturis with high suction capacity and low motive flow consumption. Since all the main line water flows through the system, slight pressure losses at the FertiKit™ outlet should be considered (see the table below).

Flow rate: 3 - 18 m³/h (13 - 85 GPM)

Suitable for main line pressure: 2.5 - 5.5 bars (36 - 79 PSI)

Dosing channels:

Accommodates a wide variety of dosing channels for fertilizer and concentrated/diluted acid:

- 50Hz: Up to 6 x 50 - 600 l/h (13 - 156 GPH)
- 60Hz: Up to 3 x 50 - 600 l/h (13 - 156 GPH)
- 60Hz: Includes compensation channel
- Optional - Concentrated acid channel, 50 l/h (13 GPH).

Total fertilizer/acid suction capacity:

- 50Hz: Up to 3600 l/h (950 GPH).
- 60Hz: Up to 1800 l/h (475 GPH).

Controller: NMC-Pro, NMC-XL, NMC-Junior, (Other controllers or manual system without controller - optional).

EC/pH: Single, monitoring and control.

Schematic diagram

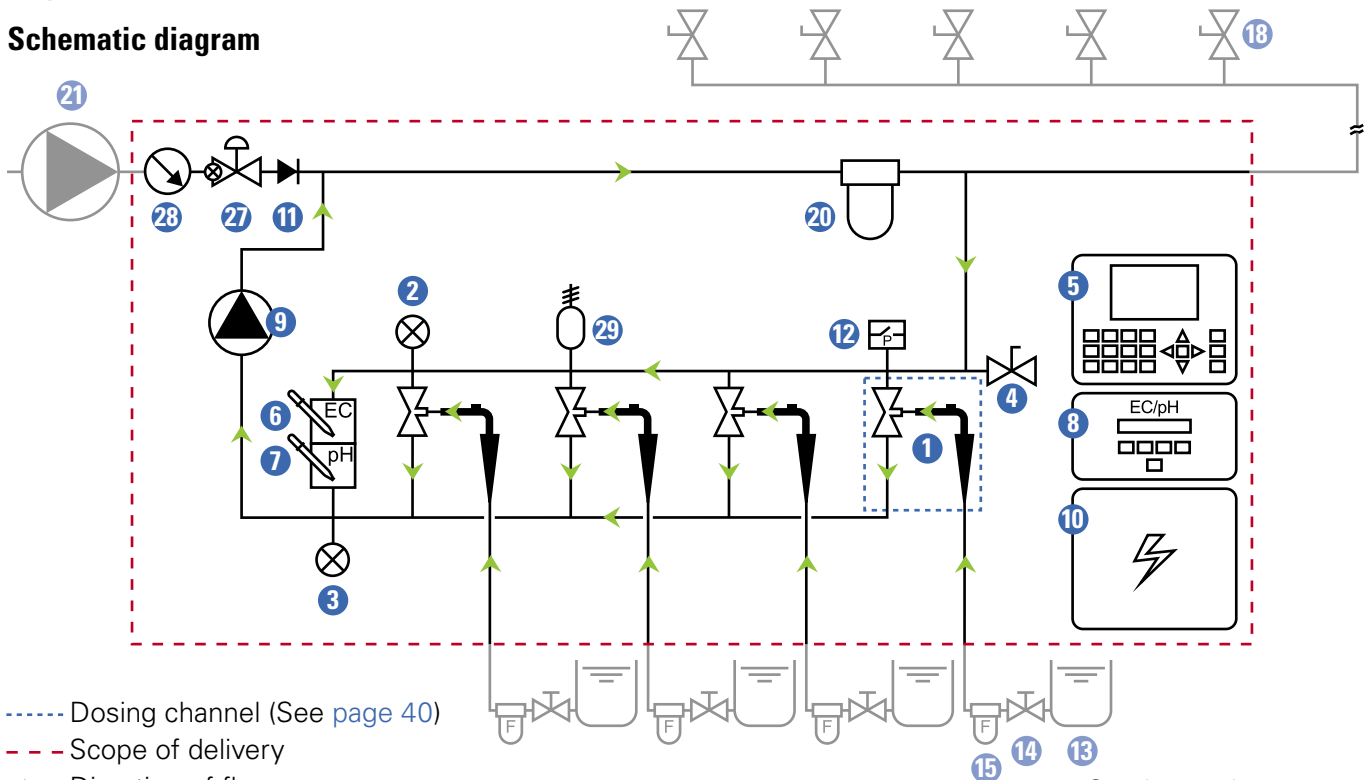

- Dosing channel (See page 40)
- - - - - Scope of delivery
- Direction of flow

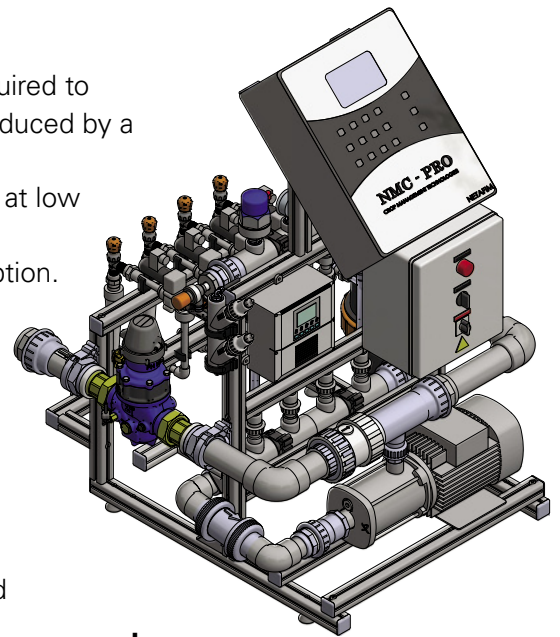

pressure losses

Flow rate m ³ /h (GPM)	Pressure losses bar (PSI)
5 (22)	0.1 (1.45)
10 (44)	0.3 (4.35)
15 (66)	0.6 (9.55)

See Legend on page 9

DESCRIPTION

PD mode

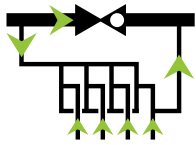

Operating principle: Utilizes the main line pressure or gravity feed.
Saves the need for a dosing booster.
Also suitable for applications where there is no electricity on the site (contact Netafim™).

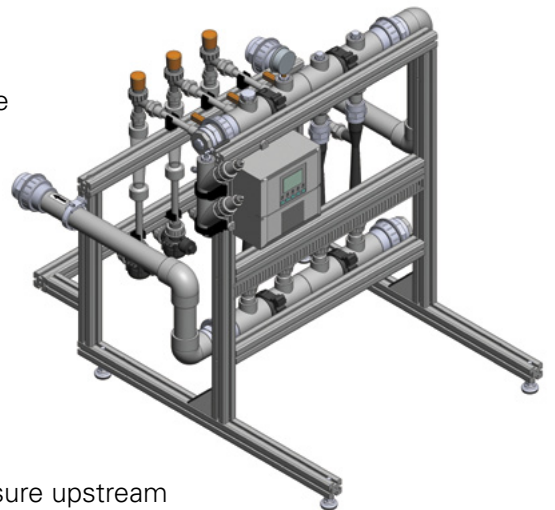

Flow rate: 10 - 200 m³/h (44 - 880 GPM)

Suitable for main line pressure: 4.5 - 8.0 Bars (65 - 116 PSI)

Additional conditions:

For the dosing channels to provide proper suction, the pressure downstream from the PRV should be at least 50% of the the pressure upstream from the PRV (The efficiency of the Venturis decreases if this condition is not met). In addition the system must supply sufficient pressure for the field demand.

Dosing channels:

Accommodates a wide variety of dosing channels for fertilizer and concentrated/diluted acid:

- Up to 4* x 50 - 370 l/h (13 - 100 GPH)
 - Optional - Concentrated acid channel, 50 l/h (13 GPH).
- Total fertilizer/acid suction capacity - up to 1480 l/h (390 GPH).

*If EC/pH is installed it occupies the location of one dosing channel (power required).

Controller: NMC-Pro, NMC-XL, NMC-Junior, NMC DC

(Other controllers or manual system without controller - optional).

EC/pH: None (Single monitoring only - optional)

Schematic diagram

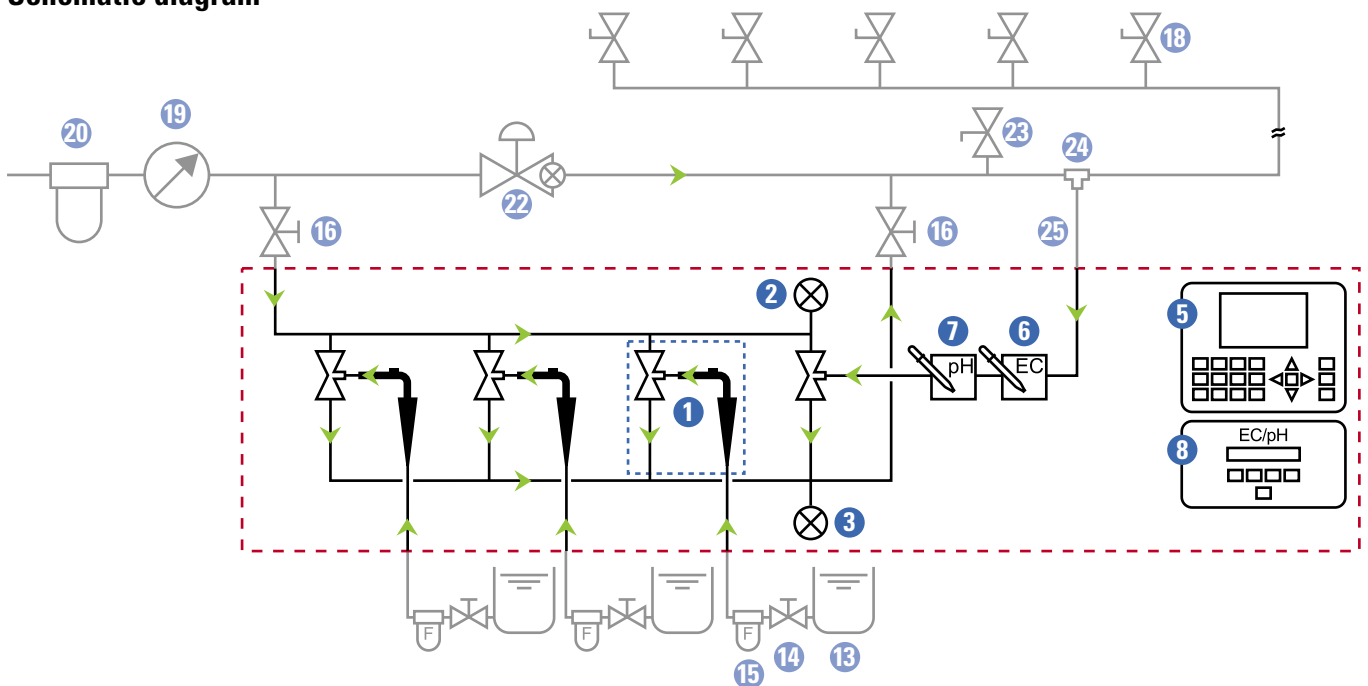

----- Dosing channel (See page 40)

- - - - - Scope of delivery

→ Direction of flow

See Legend on page 9

OPERATION AND MAINTENANCE

Operation

The routine operation of the FertiKit™ is almost totally automatic, controlled by the controller (for the operation of the controller, see the Controller Manual).

All you need is to make sure that:

- Electricity is supplied to the FertiKit™.
- Adequate quality water at the appropriate flow rate and pressure is supplied at the inlet of the FertiKit™ (see the [FertiKit™ Hydraulic Conditions Checklist](#), page 45).
- Properly dissolved fertilizers, according to the agronomist's instructions, are constantly present in the stock tanks.
- If acid is used - it is constantly present in the acid stock tank and does not exceed the recommended concentration (see [ATTENTION](#), page 6).

Dual dosing channel

If more than 4 dosing channels are required (up to 6), the dual dosing channel option is used.

- Up to 2 dual dosing channels are installed on the FertiKit™ 3G, at the ① and ④ manifold positions.
- The dual dosing channel option is applicable with 50-600 l/h (13-158 GPH) and 1000 l/h (265 GPH) Venturis only.

Dual dosing channel schematic diagram

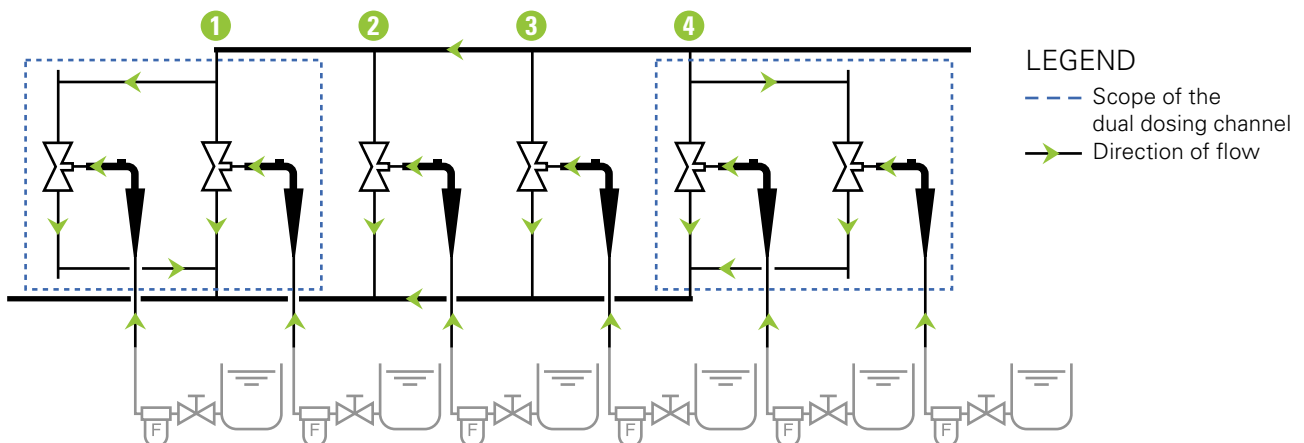

CAUTION

Only compatible products can be injected through the dual dosing channel. There are fertilizer combinations that should **never** be used in the dual dosing channel as they will induce crystallization and cause clogging of the pipes.

Fertilizer combinations prone to induce crystallization:

- Calcium Nitrate + Ammonium Sulfate => Calcium Sulfate
- Calcium Nitrate + Potassium Sulfate => Calcium Sulfate
- MKP + Calcium Nitrate => Calcium Phosphate
- MAP + Calcium Nitrate => Calcium Phosphate
- Phosphoric acid + Calcium Nitrate => Calcium Phosphate

In case of doubt regarding the use of any combination of fertilizers in the dual dosing channel, contact your Netafim™ local representative.

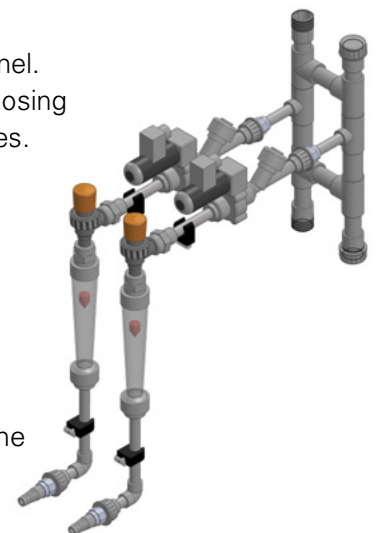

OPERATION AND MAINTENANCE

Maintenance



CAUTION

When opening or closing any manual valve, always do it gradually, to prevent damage to the system by water hammer.

To prevent failures and extend the life cycle of the FertiKit™, the user must carry out regular maintenance.

- Keep the FertiKit™ dosing unit and its immediate environment clean and dry.



CAUTION

Before calibrating the EC and pH sensors, gradually close the isolation valves and open the sampling valve until the pressure in the system is released.

- The FertiKit™ dosing unit and the supply water and irrigation system must be inspected regularly.

Regular inspection

Description	How often	Instructions
Rinsing of fertilizer filters*	Once a day	
Rinsing of supply water filters*	Once a day	
Water and fertilizer leak inspection	Once a week	Visual inspection
Calibration of the pH sensor	Every 2-4 weeks	See the enclosed EC/pH Transmitter Manual
Calibration of the EC sensor	Every 4 weeks	

* Manual filters only.

Check the FertiKit™ hydraulic conditions every 4 weeks

Consult the main line flow meter and pressure gauge, the upper manifold and lower manifold pressure gauges and the Rotameters of the dosing channels, fill in the data on the [FertiKit™ Hydraulic Conditions Checklist](#) on page 45 and make sure that all the hydraulic conditions match the reference data.

When verifying the flow rate for each dosing channel, make sure the cursors on all the Rotameters are adjusted.



NOTE

The Rotameter's scale is calibrated by the manufacturer for measurement of the flow rate of water (H₂O). Certain inaccuracies may be observed when the flow rate of liquids with different densities, such as fertilizers and acids, is measured.



ATTENTION

Once a month, read the measured flow rates of the dosing channels and compare them with the flow rates defined in the controller, to check whether any changes have occurred.

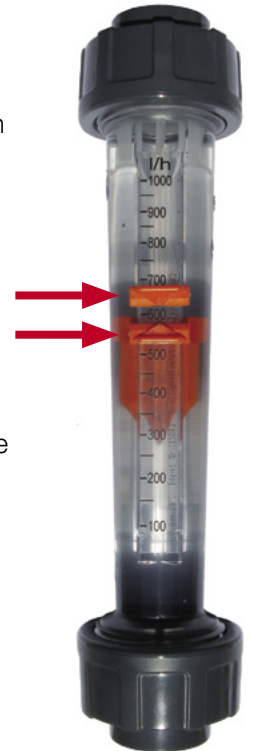

OPERATION AND MAINTENANCE

Winterization



CAUTION

When opening or closing any manual valve, always do it gradually, to prevent damage to the system by water hammer.

In areas susceptible to freezing temperatures, if the system is not required for irrigation during the winter (mainly in open field applications) perform the following procedure to avoid damage caused by freezing when the FertiKit™ is idle for the winter period:

At the beginning of winter:

- Gradually close the isolation valves and open the sampling valve until the pressure in the system is released.
- Remove EC and pH sensors and store the pH sensor immersed in KCL solution (supplied with the sensor) or in calibration buffer 4 at temperature 18-25°C (64-77°F). The pH sensor must never be dry (see the enclosed EC/pH Transmitter Manual).
- Empty the FertiKit™ of water.

At the end of winter:

- Reinstall the EC and pH sensors and calibrate them (see the enclosed EC/pH Transmitter Manual).
- Gradually open the isolation valves until the pressure in the system is restored.

TROUBLESHOOTING

This chapter is a systematic guide to the actions to be taken in the case of a malfunction of the FertiKit™.



ATTENTION

Before proceeding to troubleshoot any malfunction, make sure that:

- The controller settings regarding the dosing channels are correct and match the dosing channels of the FertiKit™ (see the Controller Manual).
- The controller settings regarding the field valves are correct (see the Controller Manual).

Perform the actions in their order of appearance until the malfunction is fixed.

If you identify faulty parts - consult your Netafim™ representative.



CAUTION

Only qualified electricians are permitted to perform electrical installations and repairs!



CAUTION

If isolation valves have been installed on the system, ensure that they are in closed position before troubleshooting any hydraulic malfunction.



ATTENTION

If fertilizers from a different manufacturer have been recently in use and changes in EC and pH are recorded, perform calibration of the system before assuming a malfunction of the FertiKit™ (see [Appendix 1 - Calibration](#), page 25).

Symptoms regarding more than one single dosing channel

If one or more of the following symptoms occur regarding more than one single dosing channel, perform the actions listed below:

Controller warnings

- Low EC
- High pH
- Low fertilizer/acid flow rate

Rotameter reading

- Low fertilizer/acid flow rate

Action

- 1) For controller warnings only - check and calibrate the EC and pH sensors (see the enclosed EC/pH Transmitter Manual).
- 2) Have a qualified electrician check that electricity is being supplied to the FertiKit™ and that all the electrical components are properly connected (see the enclosed Switchboard Manual).
- 3) Check that the hydraulic conditions comply with the reference data in the [FertiKit™ Hydraulic Conditions Checklist](#) on page 45.

If NO, restore the original hydraulic conditions according to the reference data in the [FertiKit™ Hydraulic Conditions Checklist](#) on page 45.

If YES or if the malfunction is still not fixed after restoring the original hydraulic conditions, in PL or PB mode - have a qualified electrician check the dosing booster:

Does it function? Does it rotate in the correct direction?

If not - the electrician should swap between phases L1 and L3 (see the enclosed Dosing Booster Manual).

TROUBLESHOOTING

- 4) Check for an air pocket in the dosing booster impeller chamber (see the enclosed Dosing Booster Manual): Open the FertiKit™ sampling valve until a stable flow, free of air-bubbles, is obtained.
- 5) If the original hydraulic conditions are still not restored - loosen the dosing booster's bleeding screw and wait until a stable flow, free of air-bubbles, is obtained, then retighten the bleeding screw (see the enclosed Dosing Booster Manual).
- 6) Check the dosing booster's impeller chamber for clogging:
If it is clogged - it should be dismantled and thoroughly cleaned (see the enclosed Dosing Booster Manual).

If after implementing all the above steps the malfunction is still not fixed -consult your Netafim™ representative.

Symptoms regarding a single dosing channel

If one or more of the following symptoms occur regarding a single dosing channel, perform the actions listed below:

Controller warnings

- Low EC
- High pH
- Low fertilizer/acid flow rate

Rotameter reading

- Low fertilizer/acid flow rate

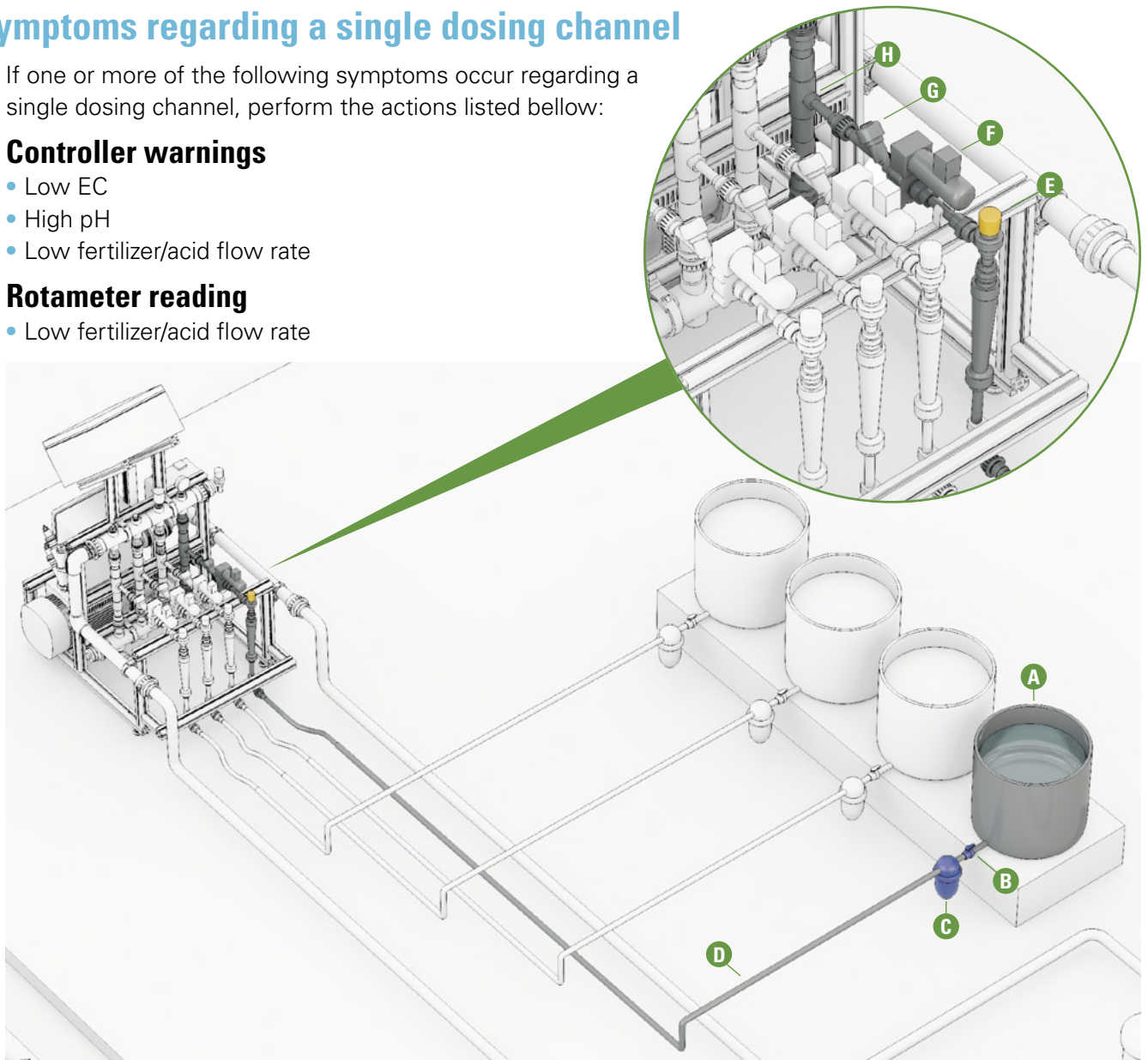

Action

- 1) Check that there is fertilizer/acid solution in the stock tank **A**.
- 2) Check that the stock tank manual valve **B** is in the OPEN position.
- 3) Check that the fertilizer/acid filter **C** is clean - If not, it should be dismantled and thoroughly cleaned.

TROUBLESHOOTING

- 4) Check the fertilizer/acid line **D** (from the stock tank to the dosing channel) for leaks and breaches and make sure all the connectors are tightened.
 - 5) Make sure the dosing channel's needle valve **E** is open according to the reference data in the [FertiKit™ Hydraulic Conditions Checklist](#) on page 45.
 - 6) Visually check the needle valve **E** for chemical damage (internal deformation).
If internal deformation is present - replace the needle valve.
 - 7) Visually check the needle valve **E** for clogging.
If clogging is present - thoroughly clean the needle valve.
 - 8) Check that the dosing valve **F** is functioning:
With the controller in MANUAL mode, set the dosing valve **F** to ON (see the enclosed Controller Manual).
The LED on the dosing valve should be lit.
If it is not - have a qualified electrician check the dosing valve's cable for electrical continuity.
If the cable is in working order - check the controller (see the enclosed Controller Manual).
If the controller and the cable are in working order - toggle the dosing valve **F** to OFF and again to ON in the controller (see the enclosed Controller Manual). A "Click" should be heard from the dosing valve with each toggle - If a "Click" is not heard, replace the dosing valve (consult your Netafim™ representative).
If a "Click" is heard and the dosing valve **F** still does not open - disconnect the dosing valve from the dosing channel and with the dosing valve set to ON in the controller (see the enclosed Controller Manual), check for clogging by injecting water at low pressure through the dosing valve.
If there is clogging - thoroughly clean the dosing valve **F** with running water.
If there is no clogging and the dosing valve **F** still does not open - replace it (consult your Netafim™ representative).
 - 9) Visually check the non-return valve **G** for any internal deformation or damage to its flat ring gasket.
If present - replace the non-return valve (consult your Netafim™ representative).
 - 10) Check the non-return valve **G** for clogging by injecting water at low pressure through it (make sure to respect the direction of flow).
If there is clogging - thoroughly clean the non-return valve **G** with running water.
 - 11) Disconnect the Venturi **H** from the manifolds and from the dosing channel and check it for clogging, visually and by injecting water at low pressure through it.
If there is clogging - thoroughly clean the Venturi **H** with running water.
 - 12) Visually check the Venturi **H** for chemical damage (internal deformation).
If internal deformation is present - replace the Venturi (consult your Netafim™ representative).
- If after implementing all the above steps the malfunction is still not fixed - consult your Netafim™ representative.

Symptoms while idle

If the following symptoms occur while the FertiKit™ is idle, perform the actions listed below:

Controller warnings

- High EC
- Low pH
- While idle - Uncontrolled fertilizer/acid flow rate or a fertilizer/acid leak or breach

TROUBLESHOOTING

Action



NOTE

When using a dosing valve with manual override (model: Fip S12 or S22), make sure the dosing valve selector is in the CLOSED position.

Check if the dosing valves leak when closed:

- 1) Close all the manual valves **B** for fertilizers and acid.
- 2) Make sure the level of the solution in all the the stock tanks is higher than the dosing valves.
- 3) With the controller in MANUAL mode, set all the dosing valves to OFF (see the enclosed Controller Manual).
- 4) Disconnect one of the the dosing valves from the non-return valve (downstream from the dosing valve).
- 5) Open the fertilizer manual valve **B**.

If a leak from the dosing valve is visible - disconnect the dosing valve from the dosing channel.

- 6) With the controller in MANUAL mode, set the dosing valve to ON (see the enclosed Controller Manual).
- 7) Thoroughly clean the dosing valve with running water.
- 8) Repeat steps 4-7 for each fertilizer and acid dosing channel.
- 9) After completing the procedure, open all the manual valves **B** for fertilizers and acid.
- 10) If the malfunction is still not fixed - replace the dosing valve.

If after implementing all the above steps the malfunction is still not fixed - consult your Netafim™ representative.



Switchboard warning

If the following symptom occurs during operation, perform the actions listed bellow:

Switchboard warning light

- The switchboard warning light is on (When the dosing booster is either ON or OFF).

Action

- 1) Check if the pressure on the main line is low compared with the reference data on the [FertiKit™ Hydraulic Conditions Checklist](#) on page 45:
If YES, restore the original main line pressure.
- 2) Check if the overload protection breaker is ON (see the enclosed Switchboard Manual).
Toggle it OFF and ON again.
If the switchboard warning light is still on or the overload protection breaker trips (turns to OFF) again, have a qualified electrician check if the dosing booster is in working order (see the enclosed Dosing Booster Manual) and check if there are irregularities in the electricity voltage supplied to the FertiKit™.

If after implementing all the above steps the malfunction is still not fixed - consult your Netafim™ representative.

CALIBRATION

The process of calibrating the FertiKit™ is carried out in three stages:

1. Calculation of dosing channels opening percentage

To finely calibrate the FertiKit™ in order to achieve homogeneous and stable dosing, perform the following calculation for each dosing channel (fertilizers and acid) to determine the amount of suction reduction needed to attain the required fertilizer/acid flow rate.

Metric units

Flow rate of the largest irrigation shift m³/hr
 X
 Dosing ratio of a single fertilizer/acid l/m³
 =
 Result: a single fertilizer/acid flow rate l/hr
 X 1.25 =
 Result: target Rotameter reading l/hr

EXAMPLE

m³/hr
 X
 l/m³
 =
 l/hr
 X 1.25 =
 l/hr

DEFINITION

Dosing ratio = $\frac{\text{The quantity of fertilizer/acid (l)}}{1 \text{ m}^3 \text{ irrigation water}}$

US units

Flow rate of the largest irrigation shift GPM
 X
 Dosing ratio of a single fertilizer/acid US gal/1000 US gal
 X 0.06 =
 Result: a single fertilizer/acid flow rate GPH
 X 1.25 =
 Result: target Rotameter reading GPH

EXAMPLE

GPM
 X
 US gal/1000 US gal
 X 0.06 =
 GPH
 X 1.25 =
 GPH

DEFINITION

Dosing ratio = $\frac{\text{The quantity of fertilizer/acid (US gal)}}{1 \text{ THG (1000 US gal) irrigation water}}$



NOTE

The Rotameter's scale is calibrated by the manufacturer for measurement of the flow rate of water (H₂O). Certain inaccuracies may be observed when the flow rate of liquids with different densities, such as fertilizers and acids, is measured.

2. Simulation test with a 10 liter (2 US gal) bucket of water

Instruments needed

- Good-quality portable EC and pH sensors, finely calibrated
- Calibration solutions for EC and pH
- Bucket with a scale for up to 10 liters (2 US gallons)
- Measuring tube or syringe with a scale for up to 100 cc (1 oz)
- Clean (preferably distilled) water for cleaning sensors during calibration
- Blotting paper for cleaning and drying

The client prepares the fertilizer solutions and the acid solution (if required) in the stock tanks according to the recipe advised by the agronomist/consultant.



ATTENTION

Ensure the fertilizers and acid solutions in the stock tanks have been thoroughly agitated before starting the simulation.

CALIBRATION

Note the required dosing ratio of each fertilizer solution and the dosing ratio of the acid solution (if used).

Fill a bucket with 10 liters (2 US gallons) of the client's supply water (without fertilizer or acid).

Measure the EC and the pH levels of the water in the bucket using calibrated portable sensors.

EXAMPLE

	EC	pH
Supply water (without fertilizer or acid)	0.3	7.8

Using a measuring tube or a syringe, take a dose from each fertilizer solution and from the acid solution (if used) according to the proportions determined by the dosing ratio (see example below) and **mix thoroughly** with the water in the bucket.

EXAMPLE

Metric units

For a fertilizers dosing ratio of 5 l/m³ each and an acid dosing ratio of 2 l/m³ the quantities for 10 liters of water in the Bucket-simulation-test will be 50 cc of each fertilizer solution and 20 cc of the acid solution

US units

For a fertilizers dosing ratio of 1.5 US gal/THG each and an acid dosing ratio of 1.1 US gal/THG the quantities for 2 US gallons of water in the Bucket-simulation-test will be 0.38 oz* of each fertilizer solution and 0.28 oz** of the acid solution

DEFINITIONS

1 US gal = 128 oz

$$* \frac{1.5 \times 2}{1000} = 0.003 \text{ US gal} = 0.384 \text{ oz}$$

$$** \frac{1.1 \times 2}{1000} = 0.0022 \text{ US gal} = 0.28 \text{ oz}$$

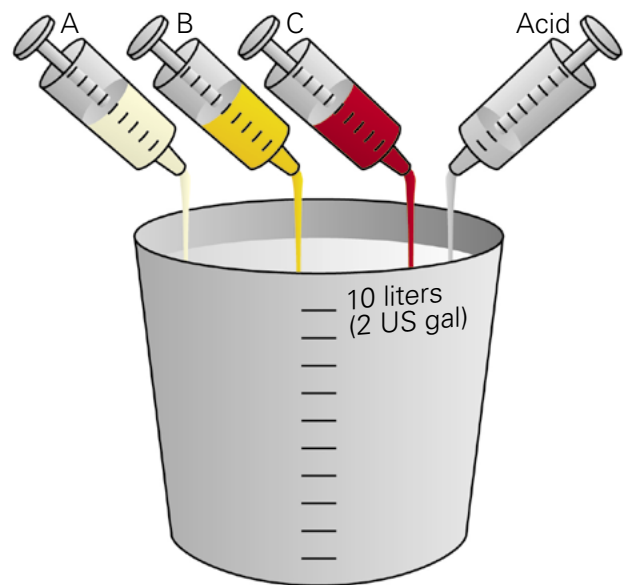

Measure the EC and the pH levels of the mixture in the bucket using calibrated portable sensors.

Compare the measured EC and pH values to the target values set by the agronomist/consultant.

EXAMPLE

	EC	pH
After adding the fertilizers and acid	1.6	5.5
Target values	1.8	5.8
Deviation from target value	11%	5%



CALIBRATION

With the controller set to operate according to EC/pH values - if the EC and pH values measured in the bucket are within a range of $\pm 30\%$ deviation from the target values, the system will be able to correct them automatically.

If the values are out of the $\pm 30\%$ range, check the data and consult the agronomist/consultant.

3. Calibration of the FertiKit™ while irrigating



WARNING

Extreme EC or pH values may damage the crop.

Perform the following procedure only after completing stage 2 above (Simulation test with a 10 liter or 2 US gallon bucket of water) with satisfactory results.



NOTE

The following steps explain the operations to be performed, regardless of the type of controller used. For the operation of your controller's interface, see the enclosed Controller Manual.

However, since the NMC Pro controller is widely used - its interface screens for the execution of each step are noted.



NOTE

Before the calibration, confirm that the EC and the pH sensors of the FertiKit™ have been calibrated according to the instructions in the enclosed EC/pH User Manual.

Define the dosing configuration, while the EC and pH controls are in the OFF position (**NMC Pro - screen 7.7**).

In the EC and pH alarm definitions, set the EC and pH alarm to the OFF position (deactivated) (**NMC Pro - screen 3.6**).

Enter the data for the irrigation valves, and the dosing ratio for each dosing channel (**NMC Pro - screens 1.1-1.2-1.3**).

Run the program (**NMC Pro - screen 2.2**).

Allow a few minutes for the pipes to fill up and the flow rate to stabilize.

Reduce the suction of the dosing channels by adjusting the manual needle valve of each dosing channel until the "target Rotameter reading" calculated in stage 1 (page 25) is attained.



NOTE

The Rotameter's scale is calibrated by the manufacturer for measurement of the flow rate of water (H₂O). Certain inaccuracies may be observed when the flow rate of liquids with different densities, such as fertilizers and acids, is measured.

Check the appropriate controller screen for the measured EC and pH values (**NMC Pro - hot screen 4**).

If the desired values have been reached, check opening percentages of the dosing valves.

The EC and pH target values should be attained with the dosing valves opened to 50% - 80% of their capacity.

If the EC and pH target values are attained with the dosing valves opened less than 50%, reduce the dosing channel suction rate, until the EC and pH target values are reached.



NOTE

Every change in the flow rate of the needle valve must be updated afterwards in the controller (**NMC Pro - screen 7.6**).

CALIBRATION

If the EC and pH target values cannot be attained, and the dosing valves are opened more than 85%, measures should be taken to increase the dosing ratio - if feasible, slightly increase the concentration of the fertilizer solution and/or reduce the water flow rate to the field during irrigation.

If not - consult the agronomist/consultant.

In a field where the flow rate changes significantly from one irrigation shift to the next, try to be at a minimum of 50% dosing valve opening for the low flow rate shift, and a maximum of 80% for the high flow rate shift.

When the calibration process is completed, return to the EC and pH control screen in the controller, define the deviation in EC and pH values for the channels and switch the EC and pH control to ON

(NMC Pro - screen 7.7-7.6).

In the EC and pH alarm definitions, define the EC and pH deviation from the target values that, if attained, will trigger the alarm and set the EC and pH alarm to the ON position (activated) **(NMC Pro - screen 3.5-3.6).**



NOTE

EC and pH values must not exceed a $\pm 30\%$ deviation from the target values.



ATTENTION

Once a month, read the measured flow rates of the dosing channels and compare them with the flow rates defined in the controller, in order to check whether changes have occurred

(NMC Pro - screen 7.6).

After completing the calibration process, fill out the [FertiKit™ Hydraulic Conditions Checklist](#) (page 45) in three copies. Make sure to fill out all the boxes of the reference row.

LIST OF PARTS

PL (PL/PS/PR/RL)

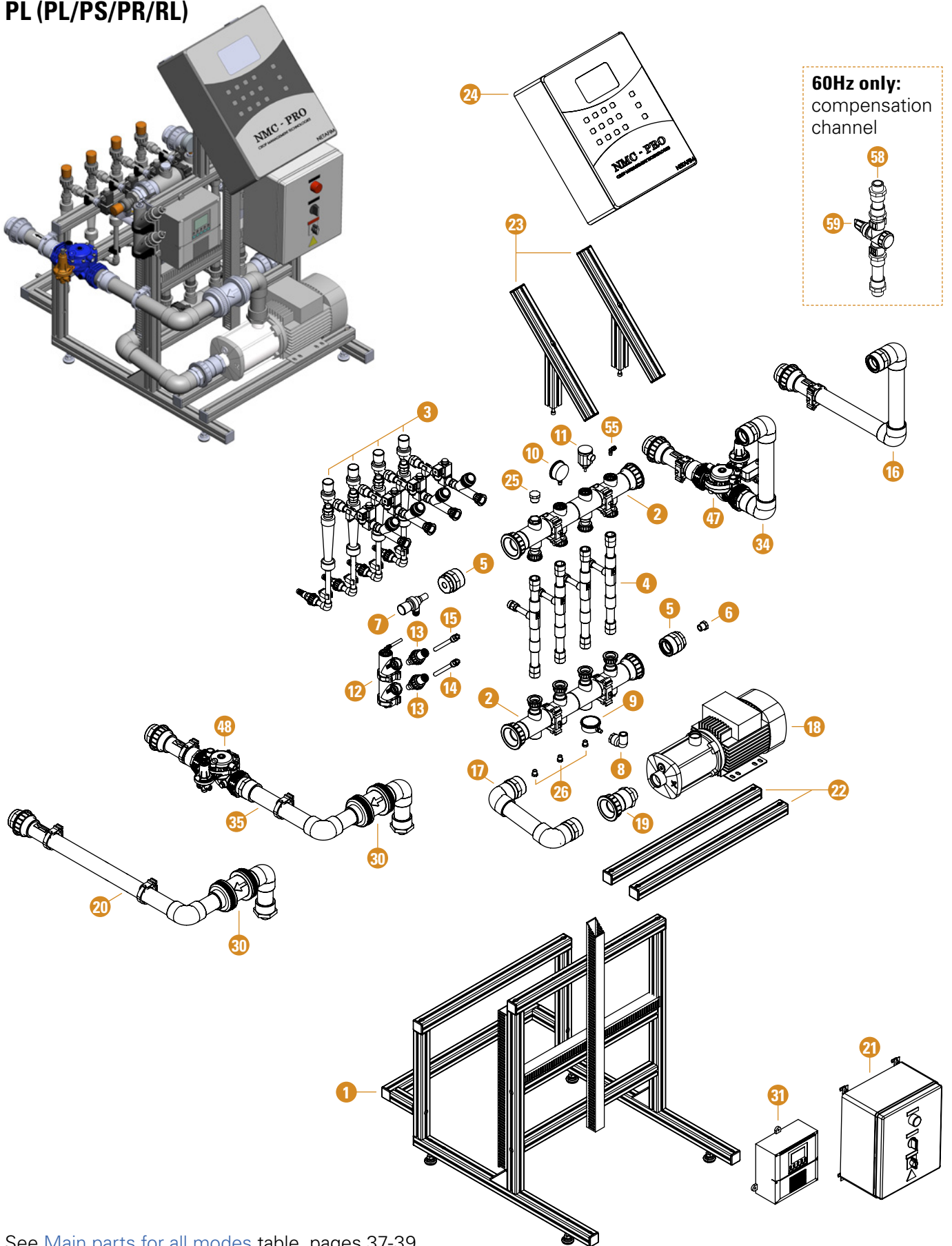

See [Main parts for all modes table](#), pages 37-39

LIST OF PARTS

PB

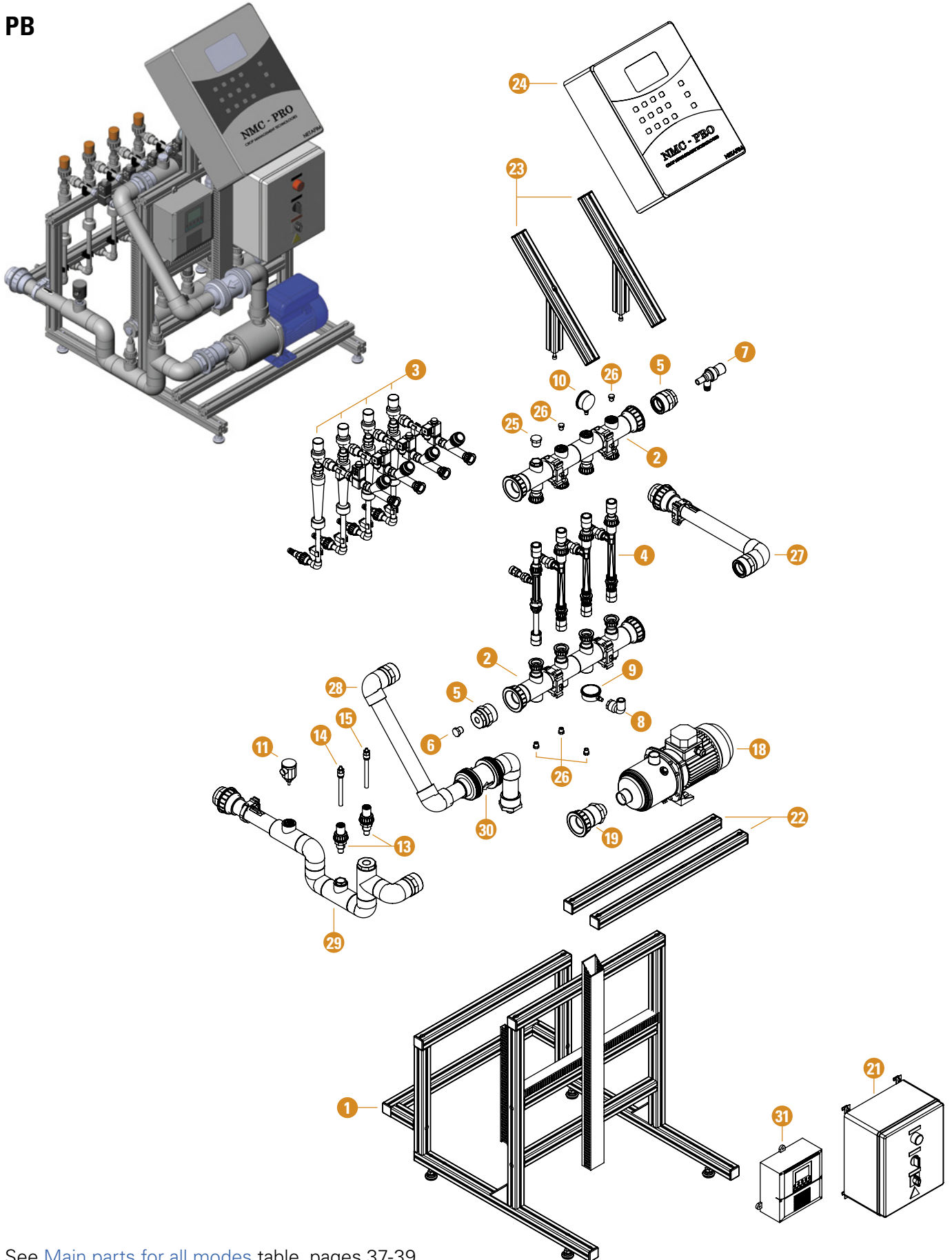

See [Main parts for all modes table](#), pages 37-39

LIST OF PARTS

SP (mm/inch)

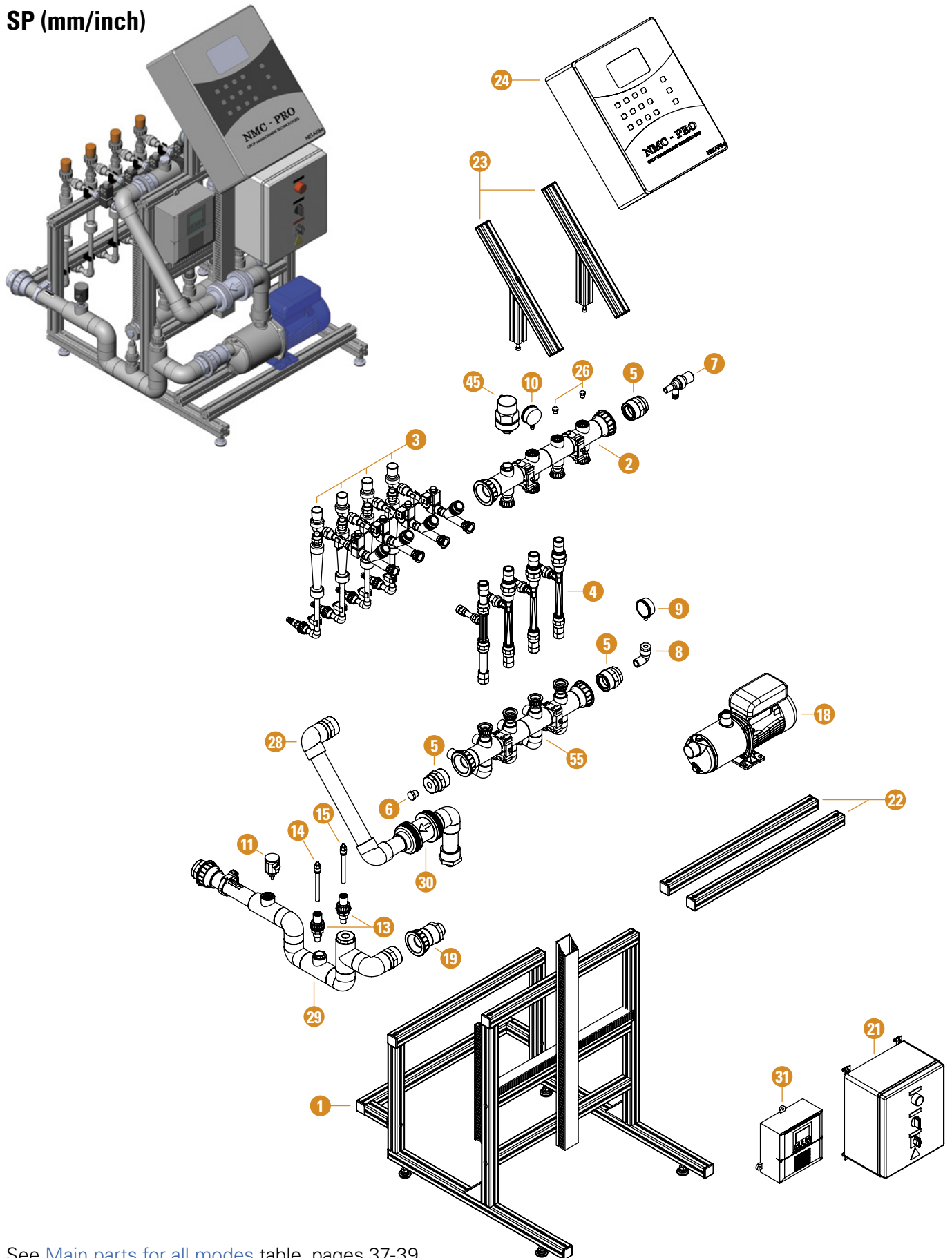

See [Main parts for all modes table](#), pages 37-39

LIST OF PARTS

MS (MS/RS)

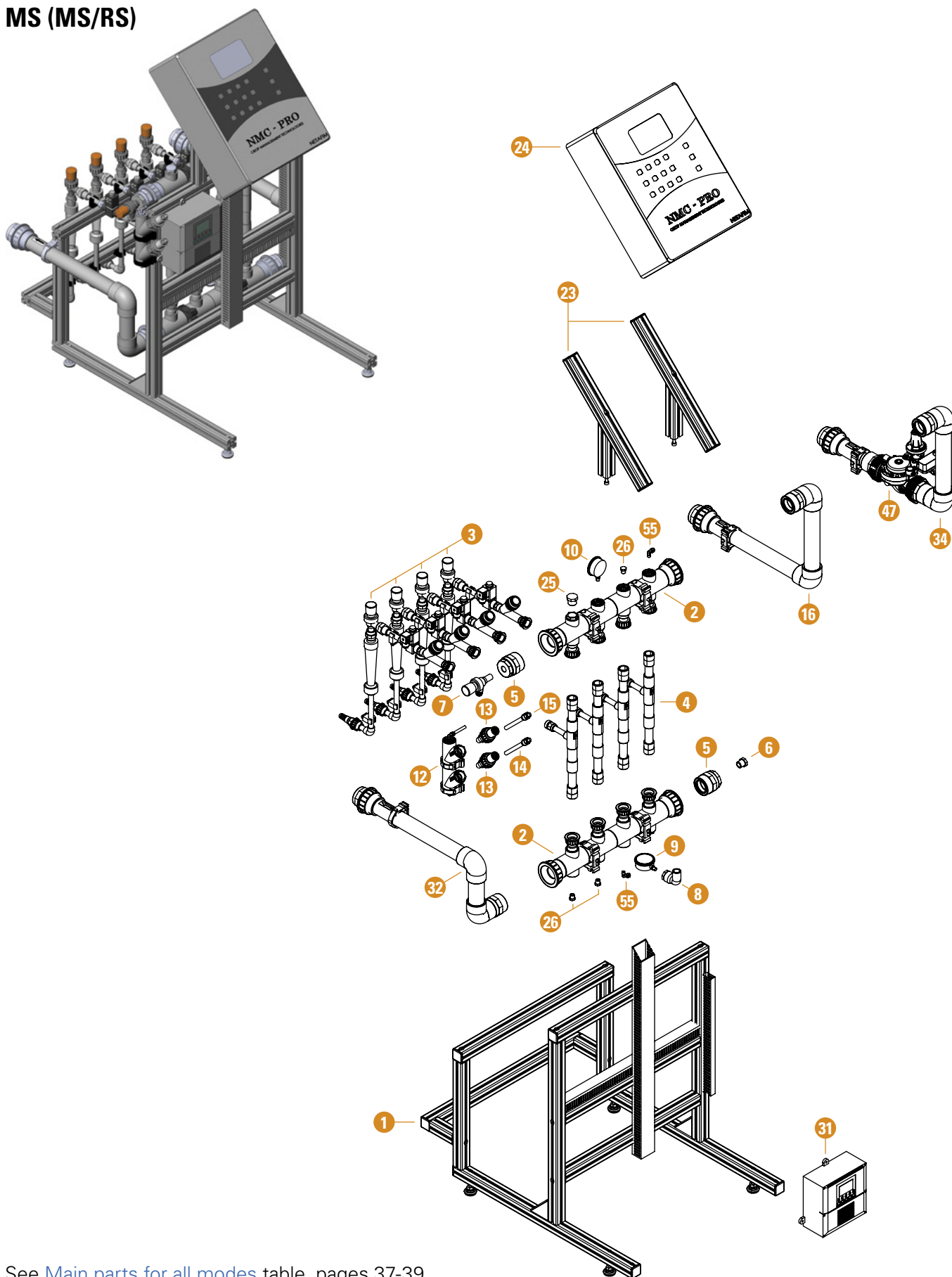

See [Main parts for all modes table](#), pages 37-39

LIST OF PARTS

IL

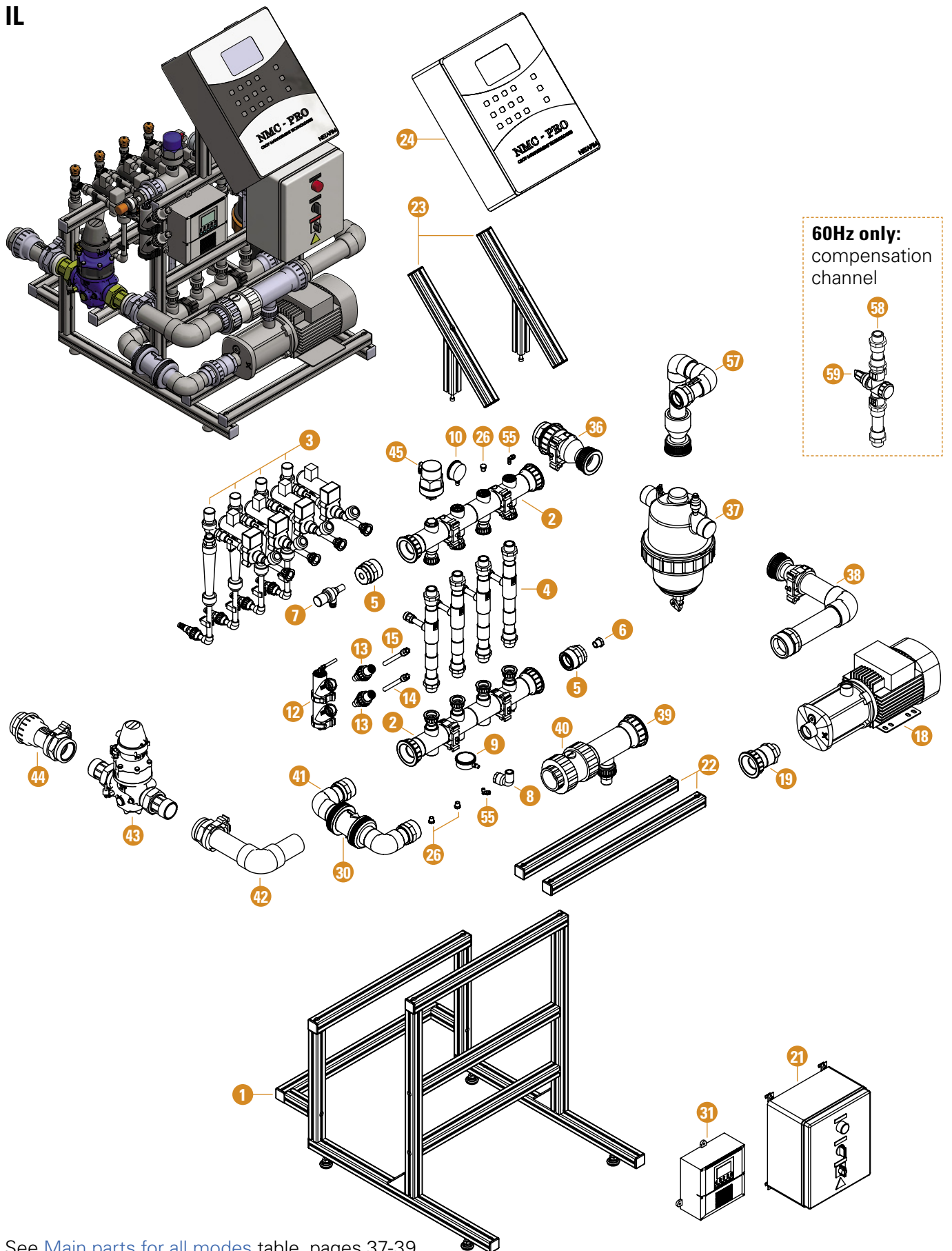

See [Main parts for all modes](#) table, pages 37-39

LIST OF PARTS

ST

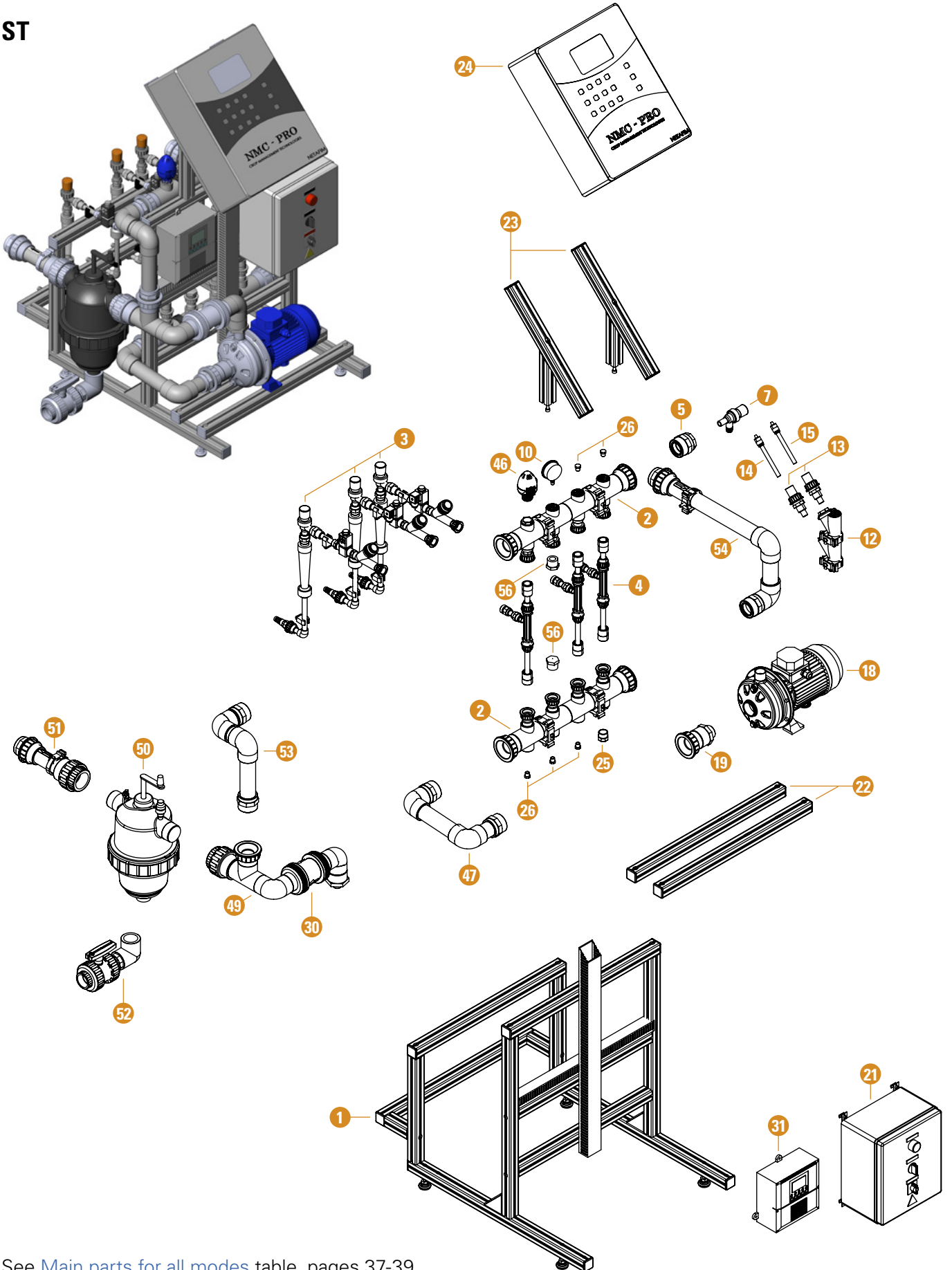

See [Main parts for all modes table](#), pages 37-39

LIST OF PARTS

PD

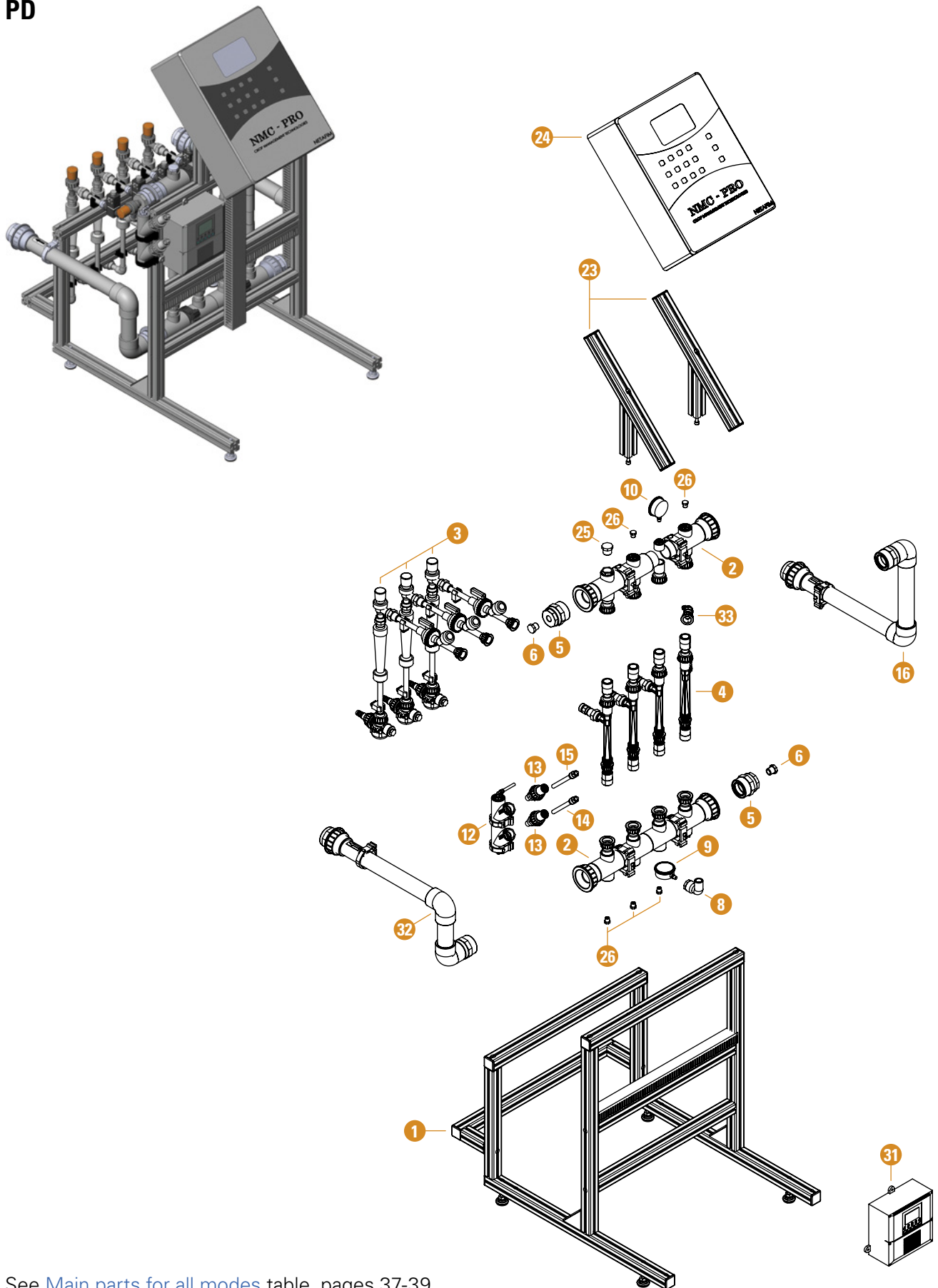

See [Main parts for all modes table](#), pages 37-39

LIST OF PARTS

MX

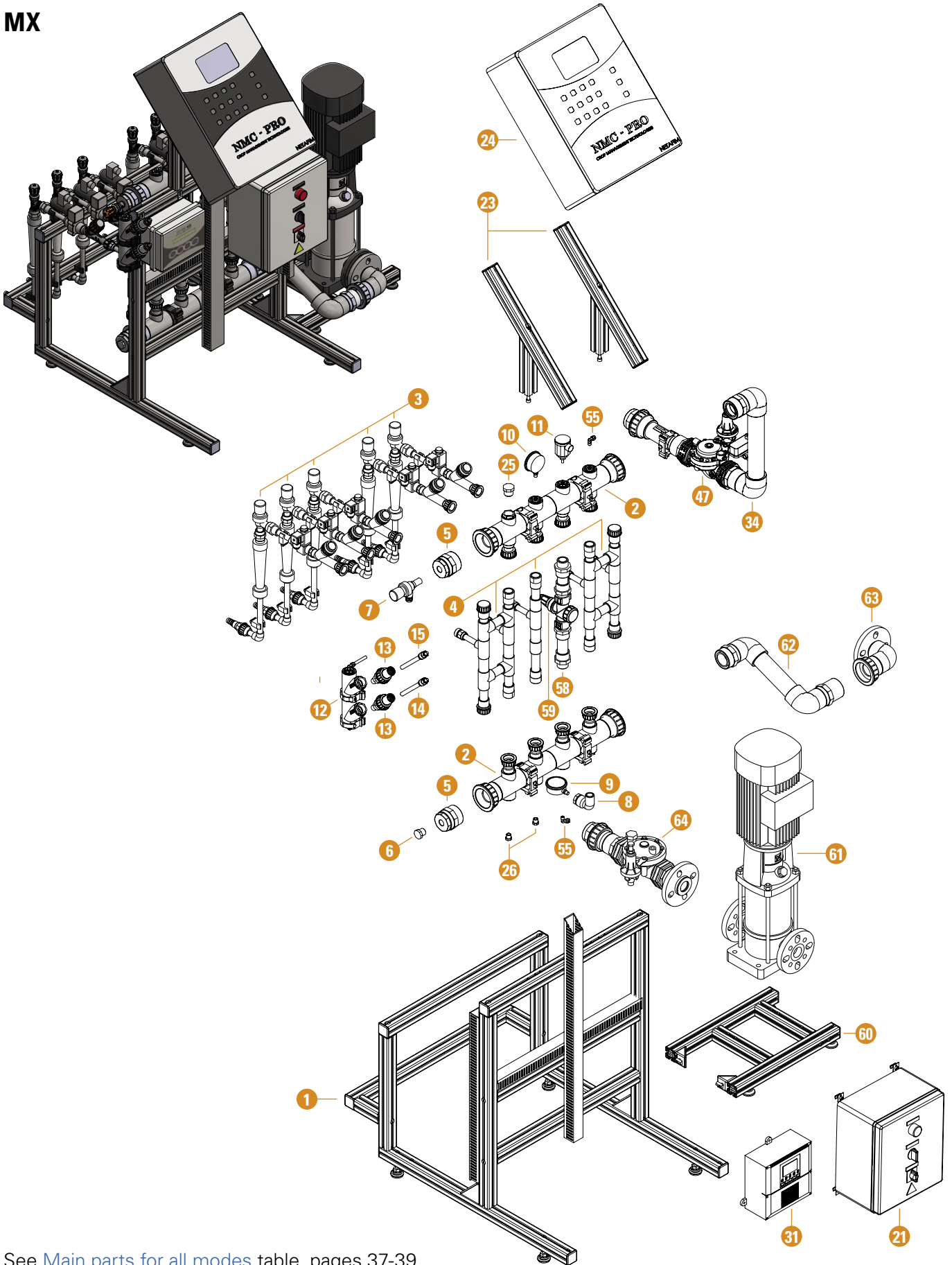

See [Main parts for all modes table](#), pages 37-39

LIST OF PARTS

Main parts for all modes

Part	Description	Cat. No.	
1	Basic frame	Not available as spare part	
2	Upper / lower manifold	33240-002100	
3	Dosing channel	See Dosing channel parts table, p. 41-42	
4	Venturi	See Venturis table, p. 44	
5	Reducer 50-1/2"	33240-002251	
6	PVC threaded plug 1/2" - male	77300-016010	
7	Sampling valve, angle diaphragm, RMRPV 1/2X20 EPDM	77500-004950	
8	Elbow for vacuum gauge	33240-004100	
9	Vacuum gauge - model 250 1-5 ATM (14.7-73.5 PSI) 1/4" BSP	77540-004150	
10	Pressure gauge - 250 GLZ 8 bar (116 PSI) 1/4" BSP	77540-003350	
11	Pressure switch - 1-3 bar (14.5-43.5 PSI), 0.3 bar (4.35 PSI) difference, 1/4"	77800-002180	
12	PL/MS EC/pH manifold	33240-003050	
13	Union adaptor set for EC/pH sensor	33120-008500	
14	ABB	pH sensor, 12mm, plastic, bared wires	45000-006701
	4G/Galcon/Fertmaster	pH sensor, 12mm, glass, BNC connection	45000-006692
15	Galcon	EC sensor, 12 mm ,temperat comp. 10K	45000-006690
	4G/ABB/Fertmaster	EC sensor, 12 mm ,temperat comp. PT100	45000-006705
16	PL/MS/PD inlet	33240-003100	
17	PL/ST U connection to pump inlet for CM5-12	33240-002850	
	PL/ST U connection to pump inlet for all other pumps	33240-002650	
18	Dosing booster	Per FertiKit™ 3G Serial Number*	
19	Dosing booster inlet adaptor 1 1/2"	Per FertiKit™ 3G Serial Number*	
20	PL - dosing booster outlet (including check valve)	Per FertiKit™ 3G Serial Number* The check valve can be ordered separately (see Part No. 30 below)	
21	Switchboard	Not available as spare part. (see Switchboard Manual)	
22	Set - Aluminum frame for dosing booster	45000-008759	
23	Set - Aluminum frame for NMC Pro controller	45000-008757	
	Set - Aluminum frame for NMC Junior/DC controller	45000-008758	
24	Controller	A complete controller is not available as spare part (See Controller Manual).	
25	PVC threaded plug 3/4" - male	77400-027100	
26	Plug 1/4"	77300-016000	
27	PB outlet	33240-002150	
28	PB - dosing booster outlet (including check valve)	Per FertiKit™ 3G Serial Number* The check valve can be ordered separately (see Part No. 30 below)	
29	Inlet	33240-002500	
30	Check valve 50-50 mm	77300-025045	
31	EC/pH monitor, 24 Volt, wall mount	74340-003580	
32	MS/PD outlet	33240-003150	
33	PD suction unit EC/pH suction via Venturi	33240-004150	

Continued on the next page

LIST OF PARTS

Main parts for all modes (continued)

Part	Description	Cat. No.	
34	PL/MS/PD inlet with PRV	33240-003110 The PRV can be ordered separately (see Part No. 47 below)	
35	PL - dosing booster outlet with PSV (including check valve)	Per FertiKit™ 3G Serial Number* The PSV can be ordered separately (see Part No. 48 below) The check valve can be ordered separately (see Part No. 30 above)	
36	IL outlet from filter	33240-002970	
37	Disc filter for FertiKit™ IL	70640-004521	
38	IL connection between pump and filter	Per FertiKit™ 3G Serial Number*	
39	IL T outlet from pump 1" (including check valve)	33240-002960 The check valve can be ordered separately (see Part No. 40 below)	
40	IL pump outlet check valve	77400-032600	
41	IL U connection to pump inlet (including check valve)	33240-002950 The check valve can be ordered separately (see Part No. 30 above)	
42	IL connection between hydrometer and pump	Per FertiKit™ 3G Serial Number*	
43	Hydrometer for FertiKit™ IL	70260-004441	
44	IL inlet to hydrometer	33240-002910	
45	Air valve	70500-001260	
46	NAVk 10 ¾" kinetic air valve PN10 BSP	32600-001000	
47	Pressure reducing valve (PRV)	Oval	70120-001715
		Dorot	71600-010612
48	Pressure sustaining valve (PSV)	Oval	70120-001760
		Dorot	71600-010611
49	ST connection pump outlet and filter (including check valve)	Per FertiKit™ 3G Serial Number* The check valve can be ordered separately (see Part No. 30 above)	
50	Manual filter 2" T tagline 120 mesh	74410-001410	
	Semi automatic filter 2" T 120 mesh	74410-001650	
	Manual filter 1½" super 120 mesh for flow up to 3 m³/h	74410-000605	
51	ST outlet from filter 1½"	33240-002805	
	ST outlet from filter 2"	33240-002800	
52	ST semi automatic filter drain kit	33240-002810	
53	ST inlet to upper manifold	33240-002820	
54	ST inlet	33240-002840	
55	Control tube elbow connector 8 mm/1/4" FT58	71000-031970	
56	Plug 1" with rubber washer for upper/lower manifold	77300-016050 and 77300-029200	
57	IL connection filter and upper manifold	Per FertiKit™ 3G Serial Number*	
58	MX low-flow compensation channel set	33240-007000	
59	MX low-flow 1" PRV P-BSP-FF-A Dir. Act., Yellow cap	71000-016380	
60	MX frame for vertical booster pump	45000-008767	
61	MX vertical dosing booster	Per FertiKit™ 3G Serial Number*	

Continued on the next page

LIST OF PARTS

Main parts for all modes (continued)

Part	Description	Cat. No.	
62	MX connection to pump inlet	For all CRI 5 pumps	33240-006900
		For all CRI 10 pumps	33240-006900
		For all CRI 15 and 20 pumps	33240-006915
63	MX booster pump inlet	For all CRI 5 pumps	33240-006905
		For all CRI 10 pumps	33240-000006
		For all CRI 15 and 20 pumps	33240-006920
64	MX booster pump outlet	For all CRI 5 pumps	33240-006910
		For all CRI 10 pumps	33240-000007
		For all CRI 15 and 20 pumps	33240-006925











* For spare part ordering call your local Netafim™ local representative having at hand the Serial Number of your FertiKit™ 3G. **Only with this number we can supply the correct part for your specific FertiKit™ 3G.** The Serial Number is inscribed on the side of the switchbox (3530-_____).

LIST OF PARTS

Dosing channels

To accommodate a variety of installations, flow rates and Nutrigation™ needs, the FertiKit™ 3G offers a wide range of dosing channels for fertilizer and acid. Some of them are listed below.

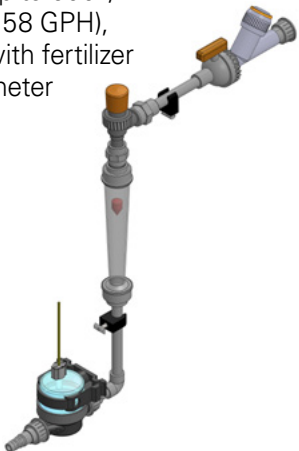
For a full overview go to the online configurator at <https://cmtconfig.netafim.com>.

<p>Electrical - up to 600 l/h (158 GPH), without manual override</p> 	<p>Electrical - up to 600 l/h (158 GPH), with manual override</p> 	<p>Electrical - up to 600 l/h (158 GPH), with fertilizer meter, without manual override</p> 	<p>Electrical - up to 600 l/h (158 GPH), with fertilizer meter, with manual override</p> 
<p>Electrical - up to 1000 l/h (264 GPH)</p> 	<p>Electrical - up to 1000 l/h (264 GPH), with fertilizer meter</p> 	<p>Hydraulic - up to 600 l/h (158 GPH), with fertilizer meter</p> 	<p>Hydraulic - up to 1000 l/h (264 GPH)</p> 
<p>Manual - up to 600 l/h (158 GPH)</p> 	<p>Manual - up to 600 l/h (158 GPH), with fertilizer meter</p> 	<p>Manual - up to 1000 l/h (264 GPH)</p> 	<p>Manual - up to 1000 l/h (264 GPH), with fertilizer meter</p> 

LIST OF PARTS

Dosing channels up to 600 l/h (158 GPH)

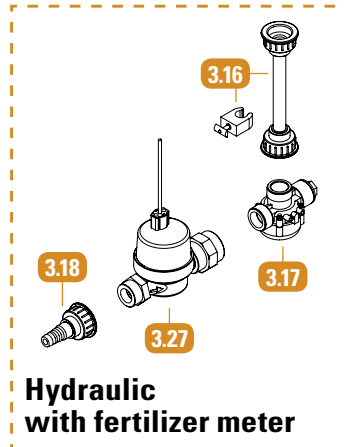
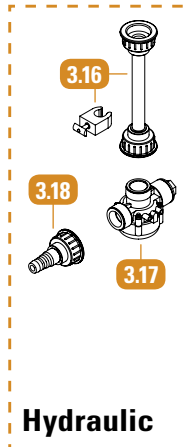
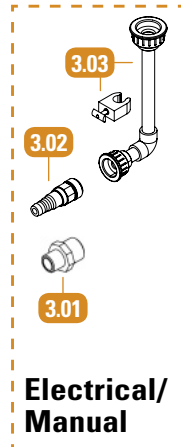
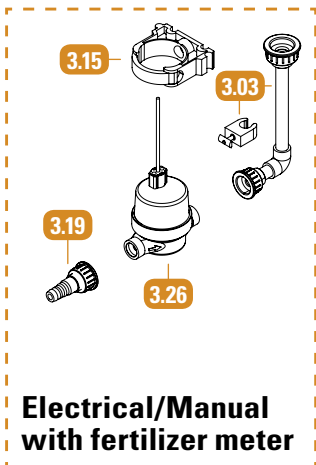
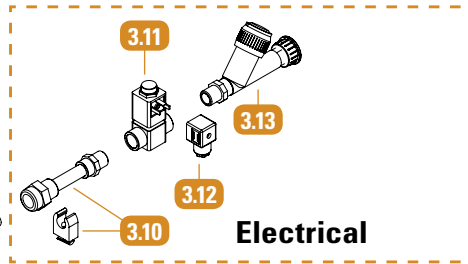
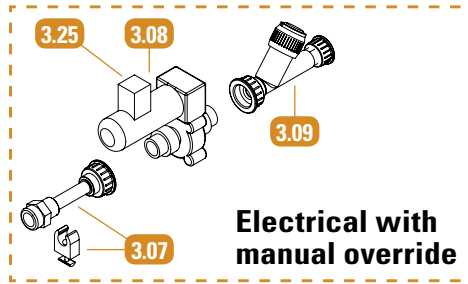
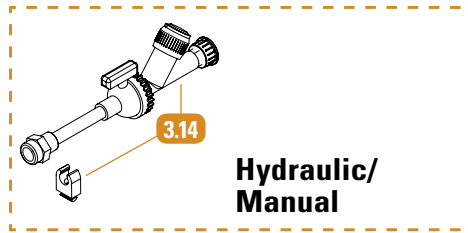

LIST OF PARTS

Dosing channels 601-1000 l/h (159-264 GPH)

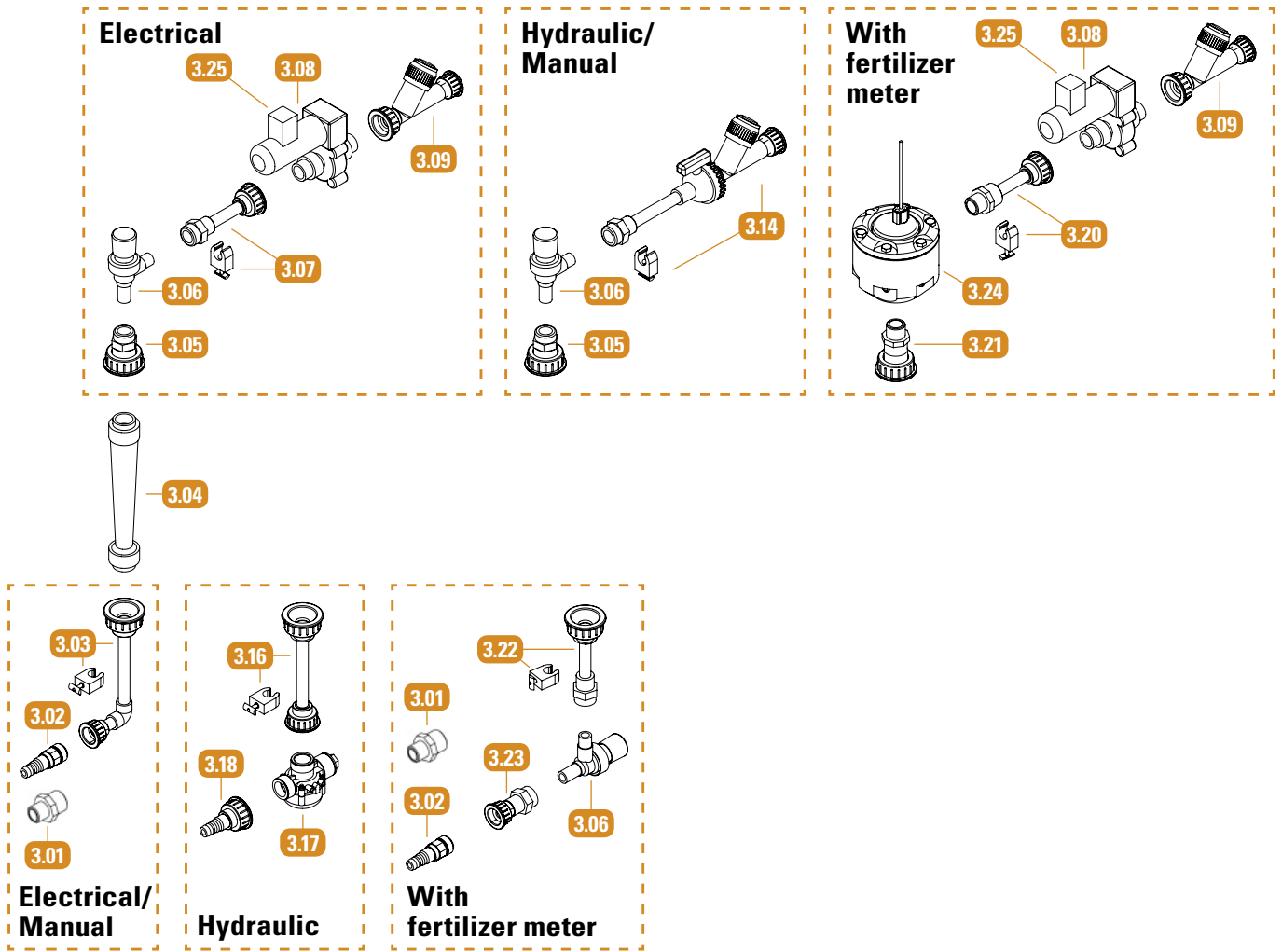

Dosing channel parts

Part	Description	Cat. No.
3.01	Nipple 3/4" 1/2"	77300-010470
3.02	Hose nozzle for dosing channel	33240-004200
3.03	Connection between hose nozzle and DFM170 ISO Rotameter (up to 400 l/h)	33240-004250
	Connection between hose nozzle and DFM185 ISO Rotameter (600 and 1000 l/h)	33240-004300
3.04	Rotameter DFM170 5-50 l/hr (1.3-13 GPH)	77540-007560
	Rotameter DFM170 15-150 l/hr (4-40 GPH)	77540-007575
	Rotameter DFM170 40-400 l/hr (10.6-106 GPH)	77540-007570
	Rotameter DFM185 60-600 l/hr (15.8-158 GPH)	77540-007577
3.05	Connection between DFM170 ISO Rotameter and needle valve	33240-004350
	Connection between DFM185 ISO Rotameter and needle valve	33240-004400
3.06	Needle valve RPRV 1/2" FPM for flow up to 400 l/h	76400-011375
	Needle valve RPRV 1/2" FPM for flow from 400 up to 1000 l/h	76400-011376

Continued on the next page

LIST OF PARTS

Dosing channel parts (continued)

Part	Description	Cat. No.
3.07	Connection between needle valve and FIP S12 ISO dosing valve 600 l/h	33240-004440
	Connection between needle valve and FIP S22 ISO dosing valve 1000 l/h	33240-004450
3.08	Dosing valve, FIP S12 24VAC 50/60 Hz Viton	77540-008480
	Dosing valve, FIP S22 24VAC 50/60 Hz Viton	77540-008500
3.09	Check valve, connecting between FIP S12 dosing valve and Venturi with EPDM ISO	76420-007955
	Check valve, connecting between FIP S12 dosing valve and Venturi with Viton ISO	76420-007960
	Check valve, connecting between FIP S22 dosing valve and Venturi with EPDM ISO	76420-007950
3.10	Connection between needle valve and Baccara BSP dosing valve	33240-004650
3.11	Dosing valve, Baccara 1/2" + Viton 24VAC 50Hz for concentrated acid	70800-001770
	Dosing valve, Baccara 1/2" + Viton 24VAC 60Hz for concentrated acid	70800-001780
	Dosing valve, Baccara 1/2" + EPDM 24VAC 50Hz for fertilizer or diluted acid	70800-001785
	Dosing valve, Baccara 1/2" + EPDM 24VAC 60Hz for fertilizer or diluted acid	70800-001790
3.12	Plug PE17A, cable 3m, LED for dosing valve	77800-004010
3.13	Check valve, connecting between Baccara BSP dosing valve and Venturi with EPDM	76420-007965
	Check valve, connecting between Baccara BSP dosing valve and Venturi with Viton	76420-007970
3.14	Manual ball valve and EPDM check valve for needle valve	33240-004800
	Manual ball valve and EPDM check valve for 1000 l/h fertilizer meter	33240-005110
3.15	Clip for fertilizer meter, up to 600 l/h	77300-024400
3.16	Connection between N.C. hydraulic valve and DFM170 ISO Rotameter	33240-005000
	Connection between N.C. hydraulic valve and DFM185 ISO Rotameter	33240-005100
3.17	AM. 3/4" N.C. hydraulic valve	74480-011100
3.18	Hose nozzle for N.C. hydraulic valve	33240-005200
3.19	Hose nozzle for fertilizer meter	33240-005250
3.20	Connection between DFM185 1000 l/h fertilizer meter and FIP S22 dosing valve	33240-005120
3.21	Connection between Rotameter and 1000 l/h DFM185 1000 l/h fertilizer meter	33240-005130
3.22	Connection between needle valve and DFM185 Rotameter for 1000 l/h fertilzier meter	33240-005140
3.23	Connection between hose nozzle and needle valve for 1000 l/h fertilzier meter	33240-005150
3.24	Arad fertilizer meter - PVC PB 3/4", EV 1L	70240-005300
3.25	Connector and cable for FIP S22/S12 24 VAC valve	77540-008520
3.26	Fertilizer meter SF 1/2" EV 0.1 L	70240-005700
	Fertilizer meter SF 1/2" EV 1 L	70240-005720
	Fertilizer meter SF 1/2" EV 1 gal	70261-011030
3.27	Fertilizer meter 600 l/h.KIT.N.C VAL.	33240-005160

LIST OF PARTS

Venturis

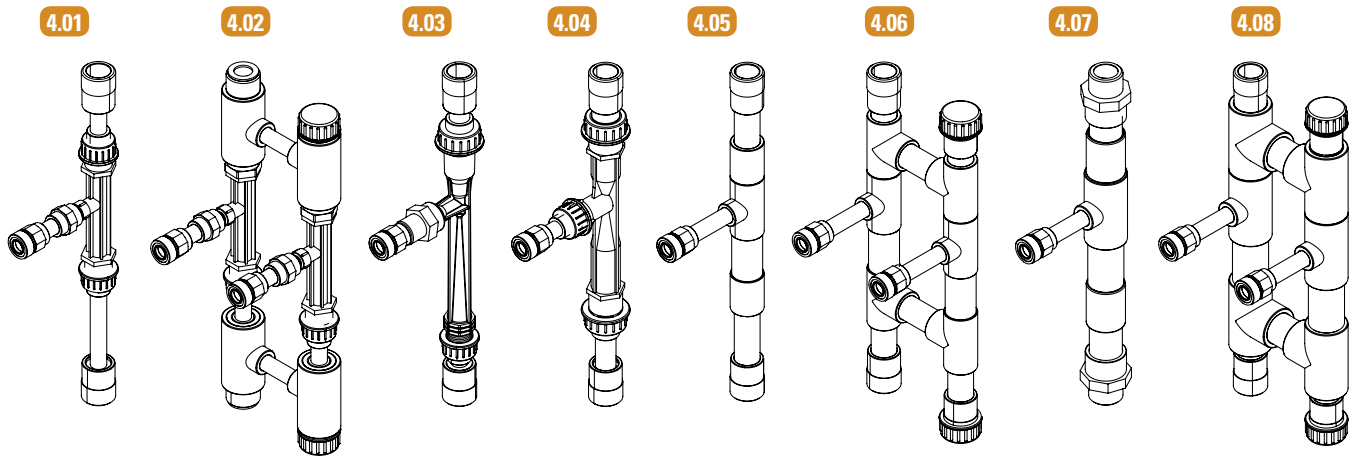

Venturis

Part	Description	Cat. No.
4.01	Venturi - PVDF - M50	33240-003200
4.02	Venturi - PVDF-M50 Dual	33240-003250
4.03	Venturi - PP - N150	33240-002300
4.04	Venturi - PP - M370	33240-002330
4.05	Venturi - PVC - N600	33240-002370
4.06	Venturi - PVC - N600 Dual	33240-002375
4.07	Venturi - PVC - N1000	33240-002390
4.08	Venturi - PVC - N1000 Dual	33240-002380

WARRANTY

Netafim™ warrants all the components of the FertiKit™ to be free of defects in material and workmanship for 1 (one) year from the date of installation, provided the installation has been reported to Netafim™ within 30 days of installation.

If the installation was not reported or was reported later than 30 days from the date of installation, Netafim™ will warrant the FertiKit™ for a period of 18 months from the date of production, according to its serial number.

If a defect is discovered during the applicable warranty period, Netafim™ will repair or replace, at its discretion, the product or the defective part.

The above does not apply to EC and pH sensors, since they are wearable. Netafim™ will warrant these items to be free of defects in material and workmanship for 3 months from the date of installation, provided the installation has been reported to Netafim™ within 30 days, or 6 months from date of production if installation was not reported or was reported later than 30 days from the date of installation.



CAUTION

When not installed, the pH sensor must be immersed in KCL solution (supplied with the sensor) or in calibration buffer 4 at temperature 18-25°C (64-77°F), protected from freezing and not be exposed to pressure greater than 6 bars (87 PSI).

Damage due to these causes is not covered by warranty.

This warranty does not extend to repairs, adjustments or replacements of a FertiKit™ or part that results from misuse, negligence, alteration, force majeure, lightning, power surge, improper installation or improper maintenance.

If a defect arises in your Netafim™ product during the warranty period, contact your Netafim™ supplier.

Limited warranty

This warranty is subject to the conditions in Netafim's official warranty statement. (For the full text of Netafim's official warranty statement, please contact Netafim™).

GROW MORE WITH LESS

WWW.NETAFIM.COM